

## 40 V, 3 A low drop Schottky rectifier

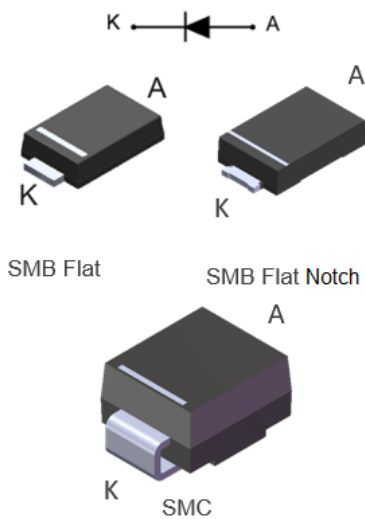

### Features

- Negligible switching losses
- Low forward voltage drop
- Low thermal resistance
- Avalanche rated
- ECOPACK2 component

### Applications

- Telecom power supply
- Set-top box power supply
- TV power supply
- Battery charger

### Description

Schottky rectifier suited for switch mode power supplies and high frequency DC to DC converters.

Packaged in SMB Flat Notch, SMB Flat and SMC, the [STPS3L40](#) is ideal for surface mounting and used in DC/DC chargers.

Product status	
STPS3L40	
Product summary	
Symbol	Value
$I_{F(AV)}$	3 A
$V_{RRM}$	40 V
$T_{j(max.)}$	150 °C
$V_{F(typ.)}$	0.40 V

# 1 Characteristics

**Table 1. Absolute ratings (limiting values at 25 °C, unless otherwise specified)**

Symbol	Parameter		Value	Unit	
$V_{RRM}$	Repetitive peak reverse voltage		40	V	
$I_{F(AV)}$	Average forward current, $\delta = 0.5$ , square wave	SMB Flat, SMB Flat Notch	$T_L = 120\text{ °C}$	3	A
		SMC	$T_L = 115\text{ °C}$		
$I_{FSM}$	Surge non repetitive forward current		$t_p = 10\text{ ms}$ sinusoidal	75	A
$P_{ARM}$	Repetitive peak avalanche power		$t_p = 10\text{ }\mu\text{s}$ , $T_j = 125\text{ °C}$	95	W
$T_{stg}$	Storage temperature range		-65 to +150	°C	
$T_j$	Maximum operating junction temperature <sup>(1)</sup>		+150	°C	

1.  $(dP_{tot}/dT_j) < (1/R_{th(j-a)})$  condition to avoid thermal runaway for a diode on its own heatsink.

**Table 2. Thermal resistance parameter**

Symbol	Parameter	Max. value	Unit
$R_{th(j-l)}$	Junction to lead	SMB Flat, SMB Flat Notch	15
		SMC	18

For more information, please refer to the following application note :

- AN5088 : Rectifiers thermal management, handling and mounting recommendations

**Table 3. Static electrical characteristics**

Symbol	Parameter	Test conditions	Min.	Typ.	Max.	Unit	
$I_R^{(1)}$	Reverse leakage current	$T_j = 25\text{ °C}$	$V_R = V_{RRM}$	-		100	$\mu\text{A}$
		$T_j = 125\text{ °C}$		-	16	40	mA
$V_F^{(1)}$	Forward voltage drop	$T_j = 25\text{ °C}$	$I_F = 3\text{ A}$	-		0.50	V
		$T_j = 125\text{ °C}$		-	0.40	0.44	
		$T_j = 25\text{ °C}$	$I_F = 6\text{ A}$	-		0.62	
		$T_j = 125\text{ °C}$		-	0.52	0.58	

1. Pulse test:  $t_p = 380\text{ }\mu\text{s}$ ,  $\delta < 2\%$

To evaluate the conduction losses, use the following equation:

$$P = 0.30 \times I_{F(AV)} + 0.047 \times I_{F(RMS)}^2$$

For more information, please refer to the following application notes related to the power losses :

- AN604: Calculation of conduction losses in a power rectifier
- AN4021: Calculation of reverse losses on a power diode

### 1.1 Characteristics (curves)

**Figure 1. Average forward power dissipation versus average forward current**

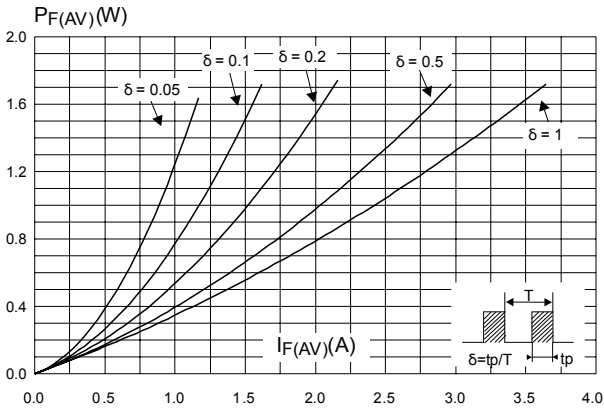

**Figure 2. Average forward current versus ambient temperature ( $\delta = 0.5$ ) (SMC)**

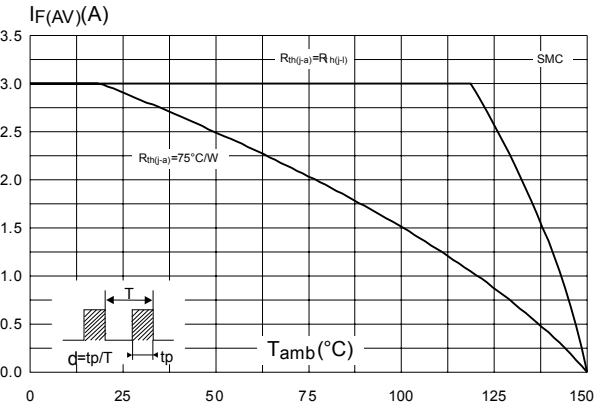

**Figure 3. Average forward current versus ambient temperature ( $\delta = 0.5$ , SMB Flat)**

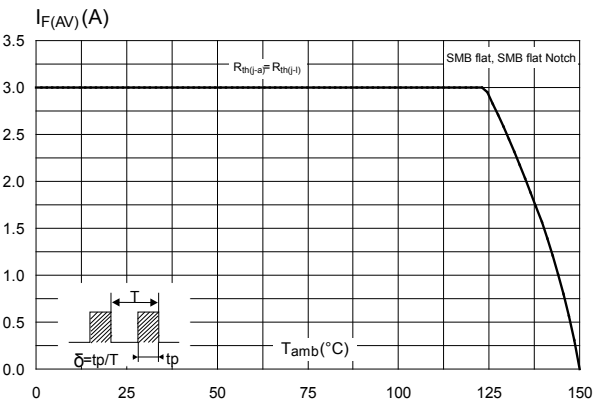

**Figure 4. Normalized avalanche power derating versus pulse duration ( $T_j = 125^\circ\text{C}$ )**

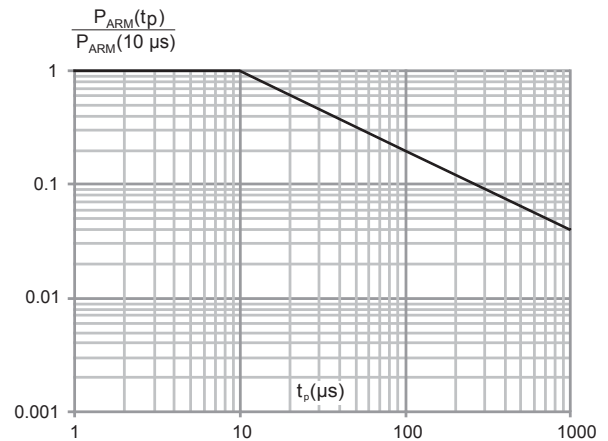

**Figure 5. Relative variation of thermal impedance junction to ambient versus pulse duration (SMC)**

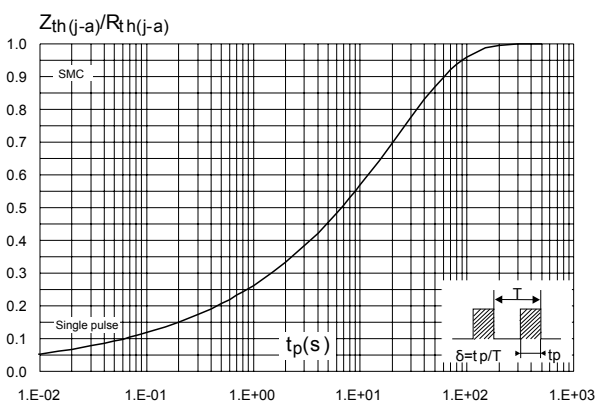

**Figure 6. Relative variation of thermal impedance junction to lead versus pulse duration (SMB flat, SMB flat Notch)**

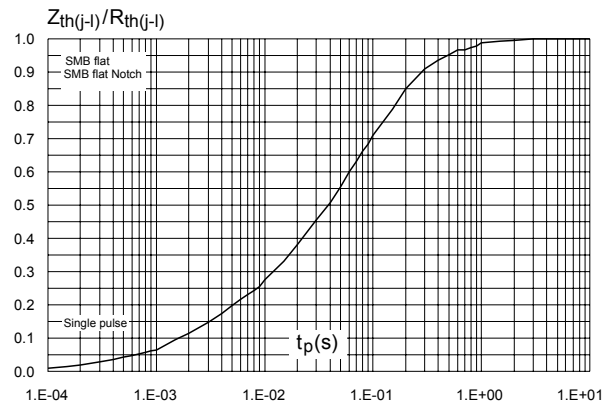

**Figure 7. Reverse leakage current versus reverse voltage applied (typical values)**

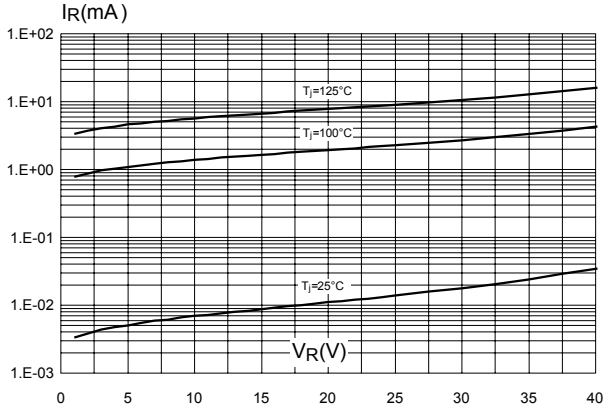

**Figure 8. Junction capacitance versus reverse voltage applied (typical values)**

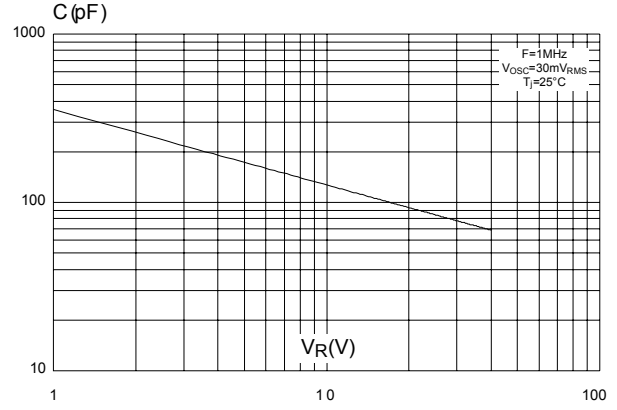

**Figure 9. Forward voltage drop versus forward current**

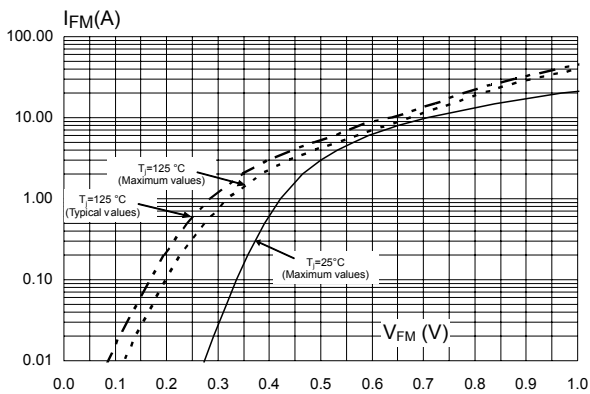

**Figure 10. Thermal resistance junction to ambient versus copper surface under each lead (SMB flat, SMB flat Notch)**

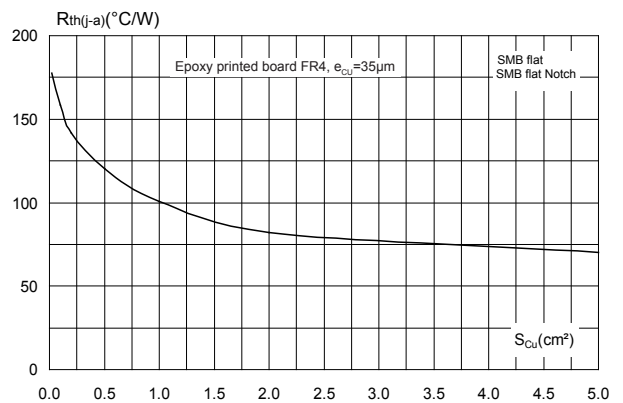

**Figure 11. Thermal resistance junction to ambient versus copper surface under each lead (SMC)**

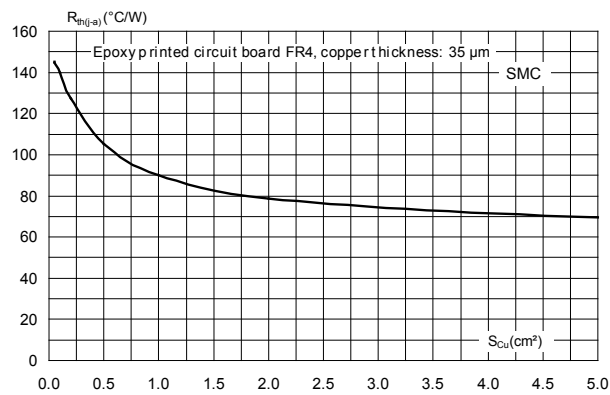

## 2 Package information

In order to meet environmental requirements, ST offers these devices in different grades of **ECOPACK** packages, depending on their level of environmental compliance. ECOPACK specifications, grade definitions and product status are available at: [www.st.com](http://www.st.com). ECOPACK is an ST trademark.

### 2.1 SMB Flat package information

- Epoxy meets UL94, V0
- Lead-free package

**Figure 12. SMB Flat package outline**

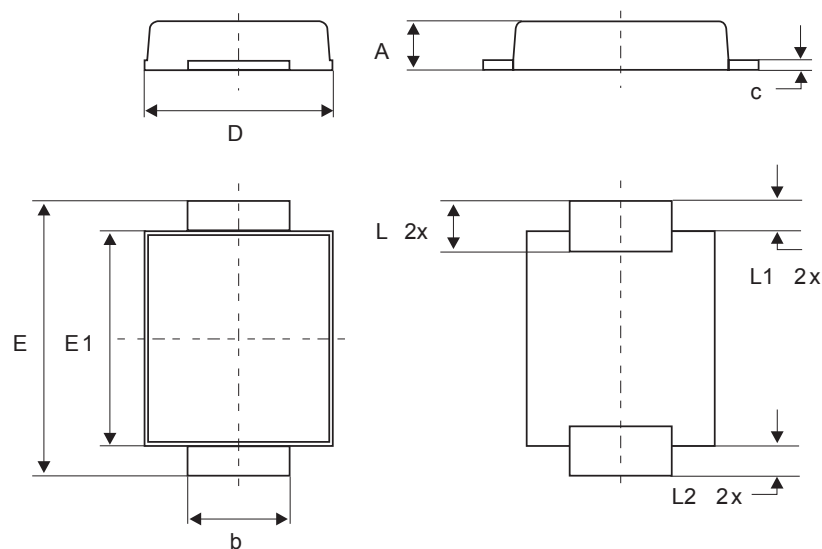

**Table 4. SMB Flat mechanical data**

Ref.	Dimensions					
	Millimeters			Inches		
	Min.	Typ.	Max.	Min.	Typ.	Max.
A	0.90		1.10	0.035		0.044
b	1.95		2.20	0.076		0.087
c	0.15		0.40	0.005		0.016
D	3.30		3.95	0.129		0.156
E	5.10		5.60	0.200		0.221
E1	4.05		4.60	0.159		0.182
L	0.75		1.50	0.029		0.060
L1		0.40			0.016	
L2		0.60			0.024	

Figure 13. Footprint recommendations, dimensions in mm (inches)

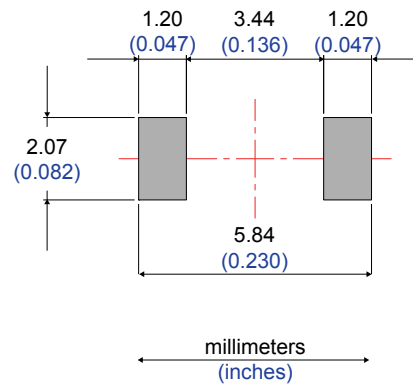

## 2.2 SMB Flat Notch package information

- Epoxy meets UL94, V0
- Lead-free package

Figure 14. SMB Flat Notch package outline

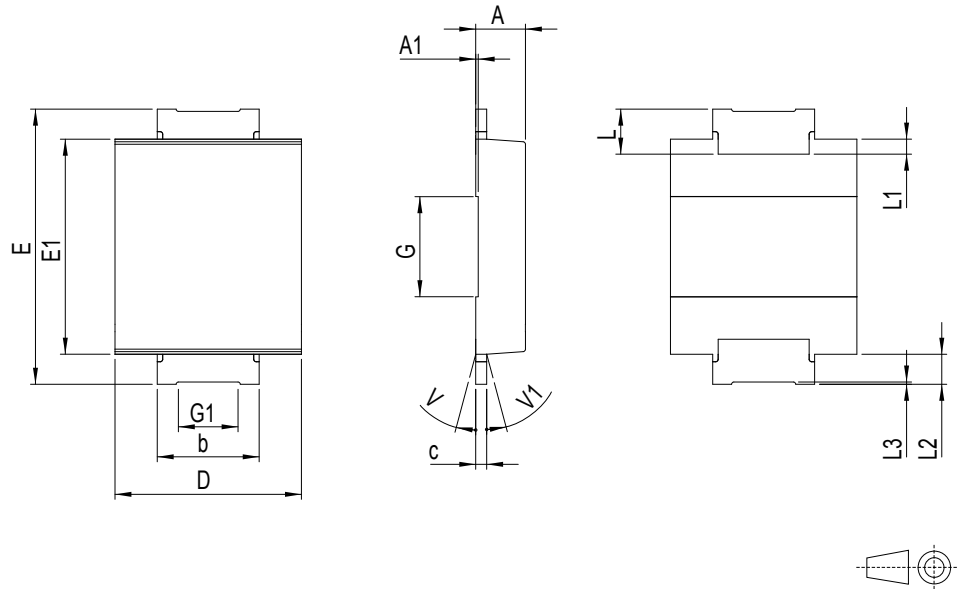
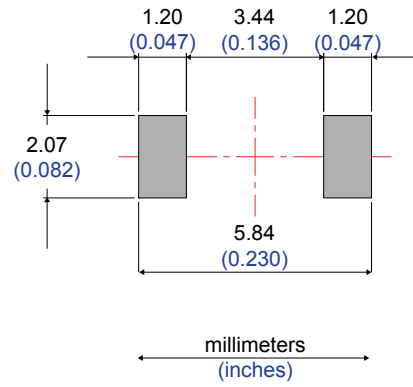

Table 5. SMB Flat Notch mechanical data

Ref.	Dimensions					
	Millimeters			Inches		
	Min.	Typ.	Max.	Min.	Typ.	Max.
A	0.90		1.10	0.035		0.043
A1		0.05			0.002	
b	1.95		2.20	0.077		0.087
c	0.15		0.40	0.006		0.016
D	3.30		3.95	0.130		0.156
E	5.20		5.60	0.205		0.220
E1	4.05		4.60	0.159		0.181
G		2.00			0.079	
G1		1.20			0.047	
L	0.75		1.20	0.030		0.047
L1		0.30			0.012	
L2		0.60			0.024	
L3	0.02			0.001		
V			8°			8°
V1			8°			8°

Figure 15. Footprint recommendations, dimensions in mm (inches)





### 2.3 SMC package information

- Epoxy meets UL94, V0

**Figure 16. SMC package outline**

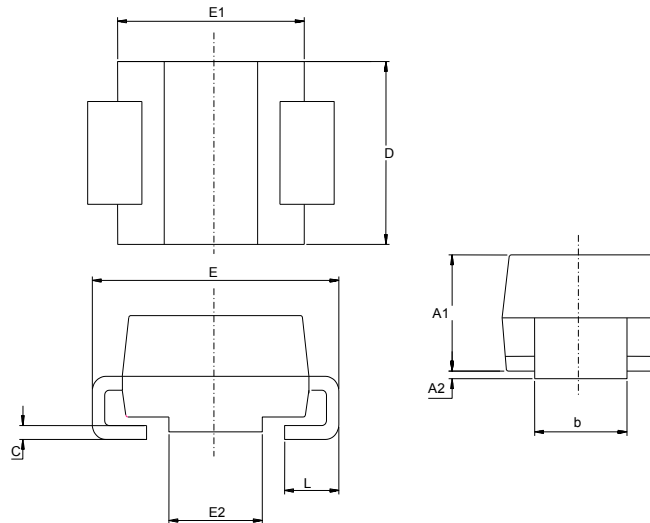

**Table 6. SMC package mechanical data**

Ref.	Dimensions			
	Millimeters		Inches (for reference only)	
	Min.	Max.	Min.	Max.
A1	1.90	2.45	0.0748	0.0965
A2	0.05	0.20	0.0020	0.0079
b	2.90	3.20	0.1142	0.1260
c	0.15	0.40	0.0059	0.0157
D	5.55	6.25	0.2185	0.2461
E	7.75	8.15	0.3051	0.3209
E1	6.60	7.15	0.2598	0.2815
E2	4.40	4.70	0.1732	0.1850
L	0.75	1.50	0.0295	0.0591

Figure 17. SMC recommended footprint

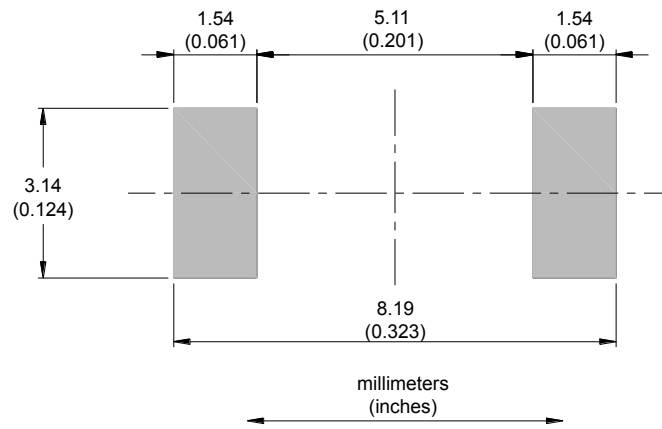

### 3 Ordering information

**Table 7. Ordering information**

Order code	Marking	Package	Weight	Base qty.	Delivery mode
STPS3L40UFN	B34	SMB Flat Notch	0.056 g	5 000	Tape and reel
STPS3L40UF	FS3L4	SMB Flat	0.050 g	5000	Tape and reel
STPS3L40S	S3L4	SMC	0.243 g	10 000	Tape and reel

## Revision history

**Table 8. Document revision history**

Date	Version	Changes
Jul-2003	2A	Last update.
08-Feb-2007	3	Reformatted to current standard. Added ECOPACK statement. Added SMBflat package.
20-May-2013	4	Updated SMC package information. Updated ECOPACK statement. Corrected Y axis labels of Figure 12.
31-Jan-2020	5	Added <a href="#">Section 2.2 SMB Flat Notch package information</a> .

**IMPORTANT NOTICE – PLEASE READ CAREFULLY**

STMicroelectronics NV and its subsidiaries (“ST”) reserve the right to make changes, corrections, enhancements, modifications, and improvements to ST products and/or to this document at any time without notice. Purchasers should obtain the latest relevant information on ST products before placing orders. ST products are sold pursuant to ST’s terms and conditions of sale in place at the time of order acknowledgement.

Purchasers are solely responsible for the choice, selection, and use of ST products and ST assumes no liability for application assistance or the design of Purchasers’ products.

No license, express or implied, to any intellectual property right is granted by ST herein.

Resale of ST products with provisions different from the information set forth herein shall void any warranty granted by ST for such product.

ST and the ST logo are trademarks of ST. For additional information about ST trademarks, please refer to [www.st.com/trademarks](http://www.st.com/trademarks). All other product or service names are the property of their respective owners.

Information in this document supersedes and replaces information previously supplied in any prior versions of this document.

© 2020 STMicroelectronics – All rights reserved