

HFA210NJ60C

HEXFRED™

Ultrafast, Soft Recovery Diode

Features

- Reduced RFI and EMI
- Reduced Snubbing
- Extensive Characterization of Recovery Parameters

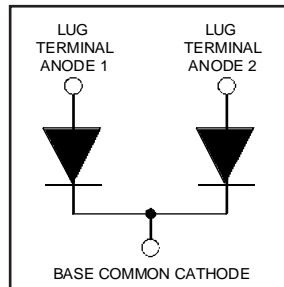

| |
|--|
| $V_R = 600V$ |
| $V_F(\text{typ.})^{\textcircled{3}} = 1.2V$ |
| $I_{F(AV)} = 210A$ |
| $Q_{rr}(\text{typ.}) = 450nC$ |
| $I_{RRM}(\text{typ.}) = 10A$ |
| $t_{rr}(\text{typ.}) = 35ns$ |
| $di_{(rec)M}/dt(\text{typ.})^{\textcircled{3}} = 240A/\mu s$ |

Description

HEXFRED™ diodes are optimized to reduce losses and EMI/RFI in high frequency power conditioning systems. An extensive characterization of the recovery behavior for different values of current, temperature and di/dt simplifies the calculations of losses in the operating conditions. The softness of the recovery eliminates the need for a snubber in most applications. These devices are ideally suited for power converters, motors drives and other applications where switching losses are significant portion of the total losses.

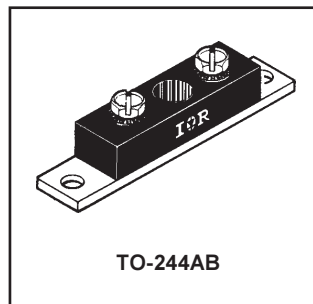

Absolute Maximum Ratings (per Leg)

| | Parameter | Max. | Units |
|---------------------------|--|-------------|---------|
| V_R | Cathode-to-Anode Voltage | 600 | V |
| $I_F @ T_C = 25^\circ C$ | Continuous Forward Current | 171 | A |
| $I_F @ T_C = 100^\circ C$ | Continuous Forward Current | 85 | |
| I_{FSM} | Single Pulse Forward Current ^① | 600 | |
| E_{AS} | Non-Repetitive Avalanche Energy ^② | 220 | μJ |
| $P_D @ T_C = 25^\circ C$ | Maximum Power Dissipation | 463 | W |
| $P_D @ T_C = 100^\circ C$ | Maximum Power Dissipation | 185 | |
| T_J | Operating Junction and | -55 to +150 | C |
| T_{STG} | Storage Temperature Range | | |

Thermal - Mechanical Characteristics

| | Parameter | Min. | Typ. | Max. | Units |
|------------|---|----------|----------|----------|---------------------|
| R_{thJC} | Junction-to-Case, Single Leg Conducting | — | — | 0.27 | $^\circ C/W$ K/W |
| | Junction-to-Case, Both Legs Conducting | — | — | 0.135 | |
| R_{thCS} | Case-to-Sink, Flat, Greased Surface | — | 0.10 | — | |
| Wt | Weight | — | 79 (2.8) | — | g (oz) |
| | Mounting Torque ^④ | 30 (3.4) | — | 40 (4.6) | lbf•in (N•m) |
| | Mounting Torque Center Hole | 12 (1.4) | — | 18 (2.1) | |
| | Terminal Torque | 30 (3.4) | — | 40 (4.6) | |
| | Vertical Pull | — | — | 80 | lbf•in |
| | 2 inch Lever Pull | — | — | 35 | |

Note: ^① Limited by junction temperature
^② $L = 100\mu H$, duty cycle limited by max T_J
^③ $125^\circ C$

^④ Mounting surface must be smooth, flat, free of burrs or other protrusions. Apply a thin even film of thermal grease to mounting surface. Gradually tighten each mounting bolt in 5-10 lbf•in steps until desired or maximum torque limits are reached. Module

HFA210NJ60C

PD-2.448 rev. B 02/99

International
IOR Rectifier

Electrical Characteristics (per Leg) @ T_J = 25°C (unless otherwise specified)

| Parameter | Min. | Typ. | Max. | Units | Test Conditions |
|---|------|------|------|-------|---|
| V _{BR} Cathode Anode Breakdown Voltage | 600 | — | — | V | I _R = 100μA |
| V _{FM} Max Forward Voltage | — | 1.3 | 1.5 | V | I _F = 105A |
| | — | 1.5 | 1.7 | | I _F = 210A |
| | — | 1.2 | 1.4 | | I _F = 105A, T _J = 125°C |
| I _{RM} Max Reverse Leakage Current | — | 6.0 | 30 | μA | V _R = V _R Rated |
| | — | 1.5 | 6.0 | mA | T _J = 125°C, V _R = 480V |
| C _T Junction Capacitance | — | 200 | 300 | pF | V _R = 200V |
| L _S Series Inductance | — | 6.0 | — | nH | From top of terminal hole to mounting plane |

Dynamic Recovery Characteristics (per Leg) @ T_J = 25°C (unless otherwise specified)

| Parameter | Min. | Typ. | Max. | Units | Test Conditions | |
|---|------|------|------|-------|---|------------------------|
| t _{rr} Reverse Recovery Time | — | 35 | — | ns | I _F = 1.0A, di _f /dt = 200A/μs, V _R = 30V T _J = 25°C | |
| t _{rr1} | — | 90 | 140 | | | T _J = 125°C |
| t _{rr2} | — | 160 | 240 | | | |
| I _{RRM1} Peak Recovery Current | — | 10 | 18 | A | T _J = 25°C V _R = 200V | |
| I _{RRM2} | — | 15 | 30 | | | T _J = 125°C |
| Q _{rr1} Reverse Recovery Charge | — | 450 | 1300 | nC | T _J = 25°C di _f /dt = 200A/μs | |
| Q _{rr2} | — | 1200 | 3600 | | | T _J = 125°C |
| di _{(rec)M} /dt1 Peak Rate of Fall of Recovery Current | — | 310 | — | A/μs | T _J = 25°C T _J = 125°C | |
| di _{(rec)M} /dt2 During t _b | — | 240 | — | | | |

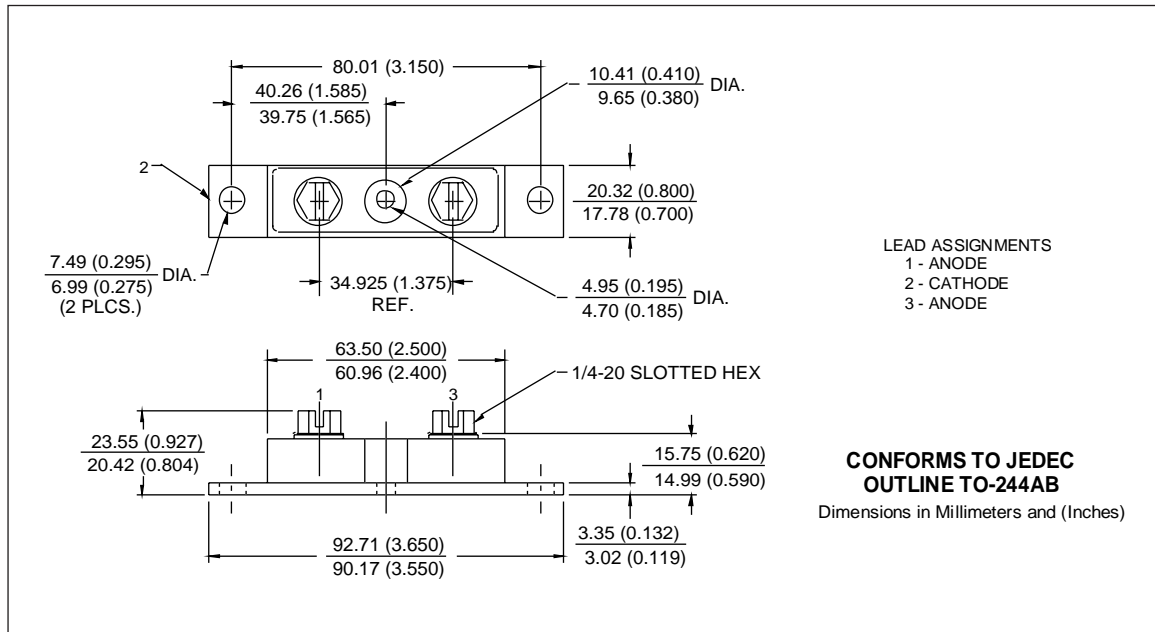

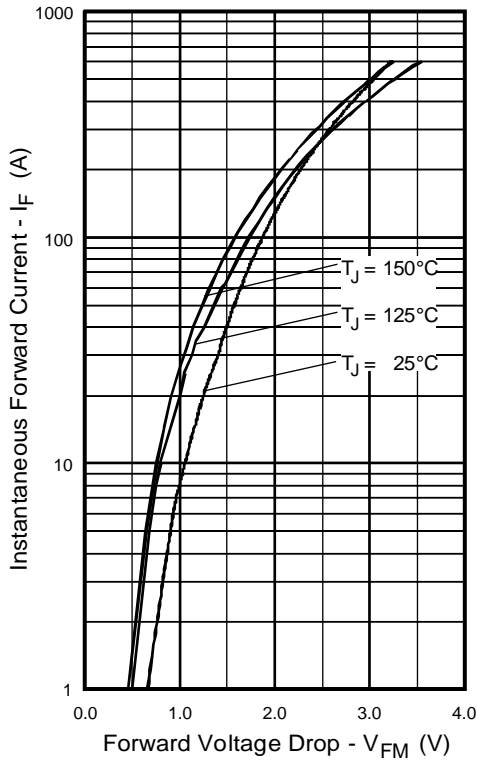

Fig. 1 - Maximum Forward Voltage Drop vs. Instantaneous Forward Current, (per Leg)

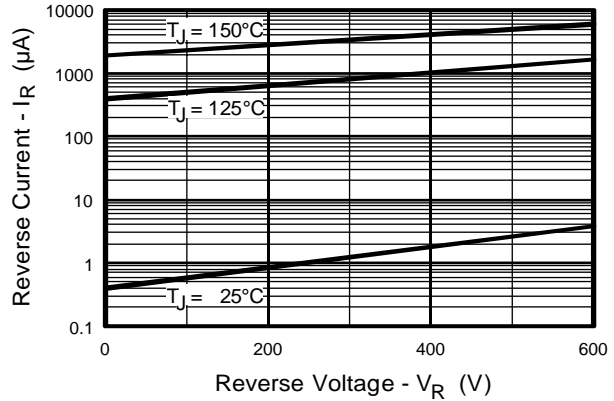

Fig. 2 - Typical Reverse Current vs. Reverse Voltage, (per Leg)

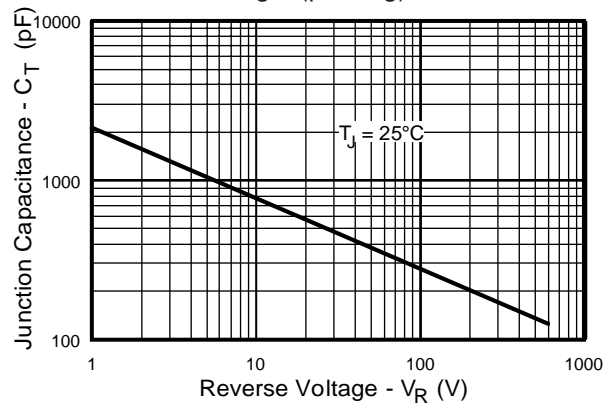

Fig. 3 - Typical Junction Capacitance vs. Reverse Voltage, (per Leg)

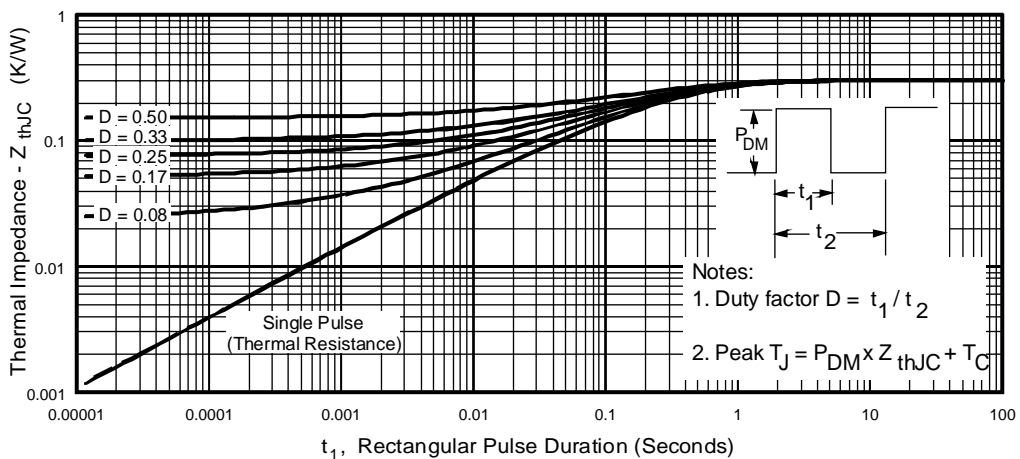

Fig. 4 - Maximum Thermal Impedance Z_{thJC} Characteristics, (per Leg)

HFA210NJ60C

PD-2.448 rev. B 02/99

International
IOR Rectifier

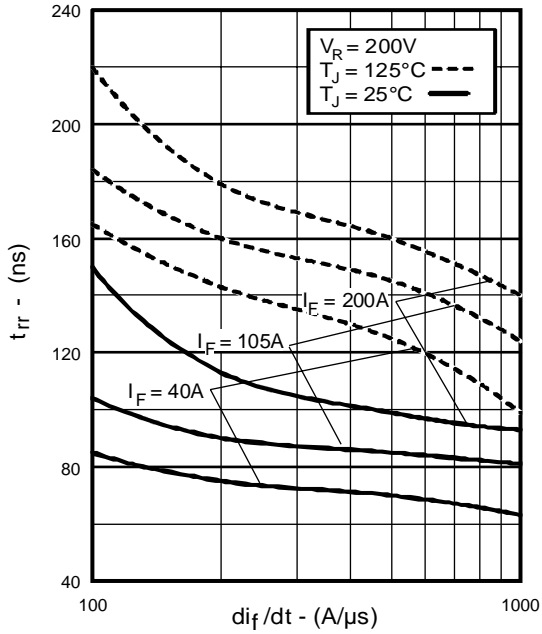

Fig. 5 - Typical Reverse Recovery vs. di_f/dt , (per Leg)

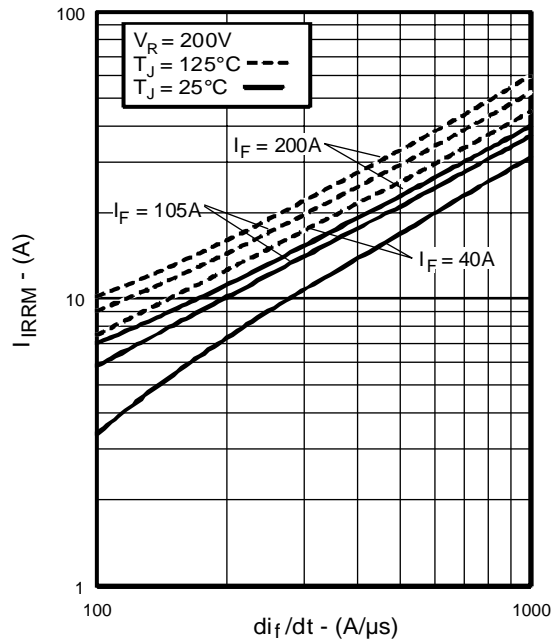

Fig. 6 - Typical Recovery Current vs. di_f/dt , (per Leg)

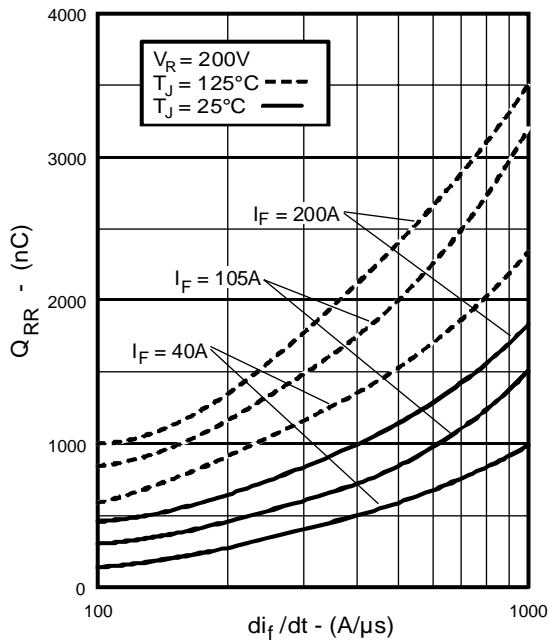

Fig. 7 - Typical Stored Charge vs. di_f/dt , (per Leg)

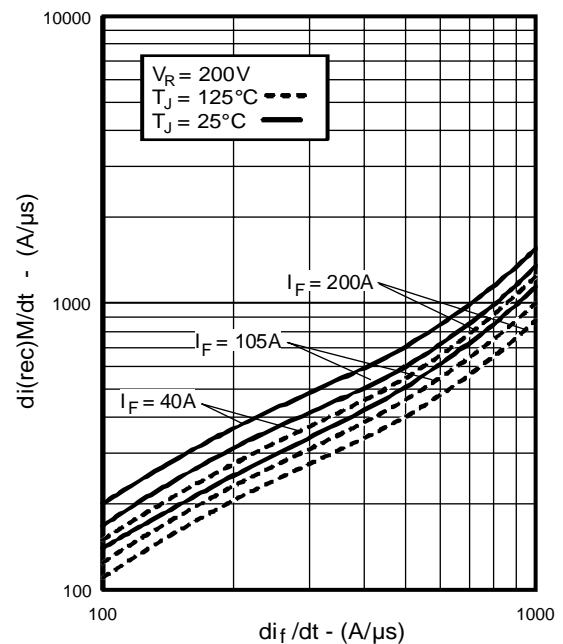

Fig. 8 - Typical $di_{(rec)M}/dt$ vs. di_f/dt , (per Leg)

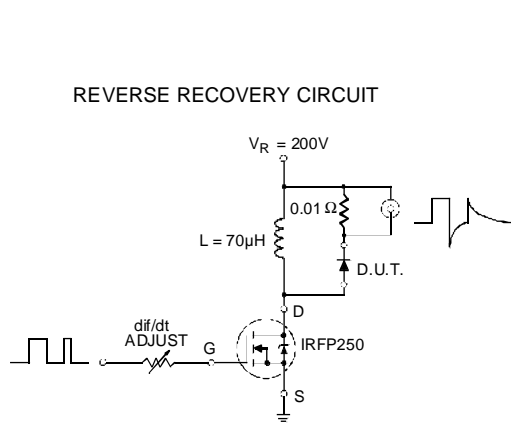

Fig. 9 - Reverse Recovery Parameter Test Circuit

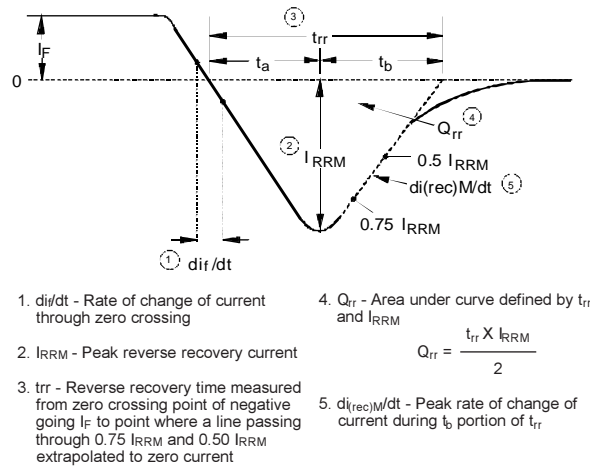

Fig. 10 - Reverse Recovery Waveform and Definitions

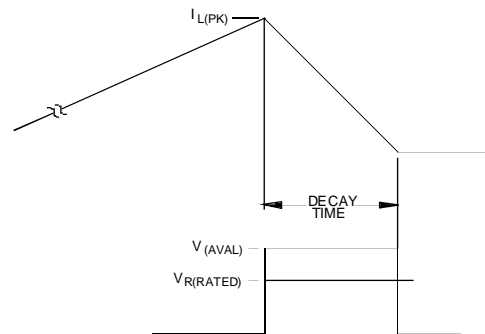
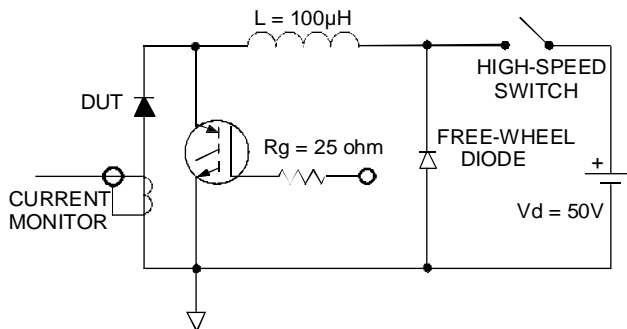

Fig. 11 - Avalanche Test Circuit and Waveforms