

# ON Semiconductor

## Is Now

# onsemi™

To learn more about onsemi™, please visit our website at  
[www.onsemi.com](http://www.onsemi.com)

---

**onsemi** and **onsemi** and other names, marks, and brands are registered and/or common law trademarks of Semiconductor Components Industries, LLC dba "**onsemi**" or its affiliates and/or subsidiaries in the United States and/or other countries. **onsemi** owns the rights to a number of patents, trademarks, copyrights, trade secrets, and other intellectual property. A listing of **onsemi** product/patent coverage may be accessed at [www.onsemi.com/site/pdf/Patent-Marking.pdf](http://www.onsemi.com/site/pdf/Patent-Marking.pdf). **onsemi** reserves the right to make changes at any time to any products or information herein, without notice. The information herein is provided "as-is" and **onsemi** makes no warranty, representation or guarantee regarding the accuracy of the information, product features, availability, functionality, or suitability of its products for any particular purpose, nor does **onsemi** assume any liability arising out of the application or use of any product or circuit, and specifically disclaims any and all liability, including without limitation special, consequential or incidental damages. Buyer is responsible for its products and applications using **onsemi** products, including compliance with all laws, regulations and safety requirements or standards, regardless of any support or applications information provided by **onsemi**. "Typical" parameters which may be provided in **onsemi** data sheets and/or specifications can and do vary in different applications and actual performance may vary over time. All operating parameters, including "Typicals" must be validated for each customer application by customer's technical experts. **onsemi** does not convey any license under any of its intellectual property rights nor the rights of others. **onsemi** products are not designed, intended, or authorized for use as a critical component in life support systems or any FDA Class 3 medical devices or medical devices with a same or similar classification in a foreign jurisdiction or any devices intended for implantation in the human body. Should Buyer purchase or use **onsemi** products for any such unintended or unauthorized application, Buyer shall indemnify and hold **onsemi** and its officers, employees, subsidiaries, affiliates, and distributors harmless against all claims, costs, damages, and expenses, and reasonable attorney fees arising out of, directly or indirectly, any claim of personal injury or death associated with such unintended or unauthorized use, even if such claim alleges that **onsemi** was negligent regarding the design or manufacture of the part. **onsemi** is an Equal Opportunity/Affirmative Action Employer. This literature is subject to all applicable copyright laws and is not for resale in any manner. Other names and brands may be claimed as the property of others.

# CMPWR101

## 250 mA SmartOR™ Regulator with V<sub>AUX</sub> Switch

### Product Description

The ON Semiconductor's SmartOR™ CMPWR101 is a low dropout regulator that delivers up to 250 mA of load current at a fixed 3.3 V output. An internal threshold level (typically 4.1 V) is used to prevent the regulator from being operated below dropout voltage. The device continuously monitors the input supply and will automatically disable the regulator when V<sub>CC</sub> falls below the threshold level. When the regulator is disabled, a low impedance, fully integrated switch is enabled which allows the output to be directly powered from an auxiliary 3.3 V supply.

When V<sub>CC</sub> is restored to a level above the select threshold, the low impedance switch is disabled and the regulator is once again enabled.

All the necessary control circuitry needed to provide a smooth and automatic transition between the supplies has been incorporated. This allows V<sub>CC</sub> to be dynamically switched without loss of output voltage.

An output logic signal, DRIVE, is active LOW whenever the internal regulator is disabled.

The CMPWR101 is housed in a 8-pin SOIC package and is available with RoHS compliant lead-free finishing.

### Features

- Automatic Detection of V<sub>CC</sub> Input Supply
- Glitch-Free Output During Supply Transitions
- Built-In Hysteresis During Supply Selection
- 250 mA Output Maximum Load Current
- Fully Integrated V<sub>AUX</sub> Switch
- Overload Current Protection
- Short Circuit Current Protection
- Operates from Either V<sub>CC</sub> or V<sub>AUX</sub>
- 8-Pin SOIC Package
- These Devices are Pb-Free and are RoHS Compliant

### Applications

- PCI Adapter Cards
- Network Interface Cards (NICs)
- Dual Power Systems
- Systems with Standby Capabilities



ON Semiconductor®

<http://onsemi.com>

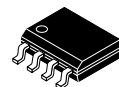

SOIC 8  
R SUFFIX  
CASE 751BD

### MARKING DIAGRAM

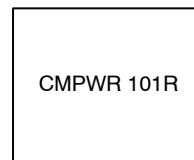

CMPWR 101R = CMPWR101R

### ORDERING INFORMATION

Device	Package	Shipping†
CMPWR101R	SOIC (Pb-Free)	2500/Tape & Reel

†For information on tape and reel specifications, including part orientation and tape sizes, please refer to our Tape and Reel Packaging Specification Brochure, BRD8011/D.

# CMPWR101

## TYPICAL APPLICATION CIRCUIT

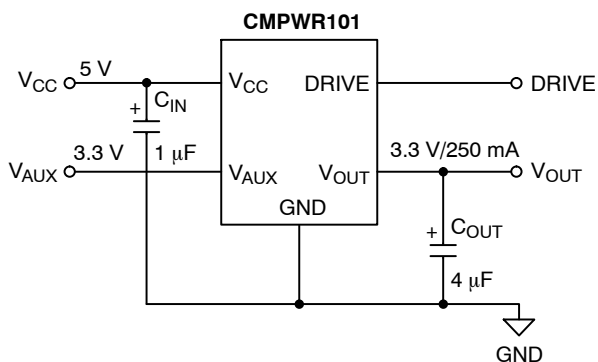

## SIMPLIFIED ELECTRICAL SCHEMATIC

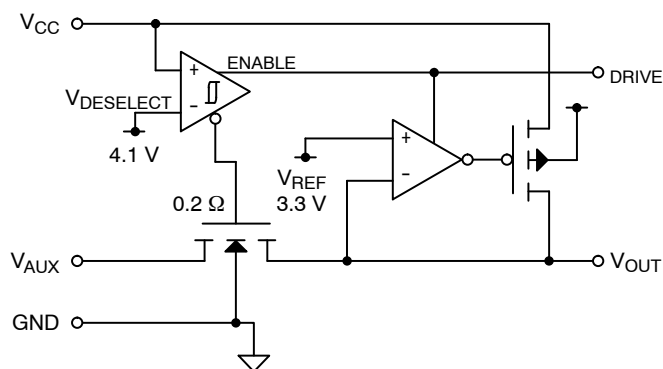

## PACKAGE / PINOUT DIAGRAM

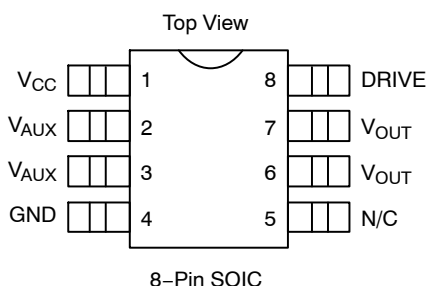

**Table 1. PIN DESCRIPTIONS**

Pin(s)	Name	Description
1	V <sub>CC</sub>	V <sub>CC</sub> is the power source for the internal regulator and is monitored continuously by an internal controller circuit. Whenever V <sub>CC</sub> exceeds V <sub>CCSEL</sub> (4.25 V typically), the internal regulator will be enabled and deliver a fixed 3.3 V at V <sub>OUT</sub> . When V <sub>CC</sub> falls below V <sub>CCDES</sub> (4.10 V typically), the regulator will be disabled. Internal loading on this pin is typically 0.6 mA when the regulator is enabled, which reduces to 0.1 mA whenever the regulator is disabled. If V <sub>CC</sub> falls below the voltage on the V <sub>AUX</sub> pin, the V <sub>CC</sub> loading will further reduce to only a few microamperes. During a V <sub>CC</sub> power-up or power-down sequence, there will be an effective step increase in V <sub>CC</sub> line current when the regulator is enabled/disabled. This line current transient will cause a voltage disturbance at the V <sub>CC</sub> pin. The magnitude of the disturbance will be directly proportional to the effective power supply source impedance being delivered to the V <sub>CC</sub> input. A built-in hysteresis voltage of 150 mV has been incorporated to minimize any chatter during supply changeover. It is recommended that the power supply connected to the V <sub>CC</sub> input should have a source resistance of less than 0.25 Ω to minimize the event of chatter during the enabling/disabling of the regulator. If the V <sub>CC</sub> pin is within a few inches of the main input filter, a capacitor may not be necessary. Otherwise an input filter capacitor in the range of 1 μF to 10 μF will help to lower the effective source impedance.
2-3	V <sub>AUX</sub>	V <sub>AUX</sub> is the auxiliary power source. When selected, (V <sub>CC</sub> < V <sub>CCDES</sub> ), the auxiliary supply is directly connected to V <sub>OUT</sub> , via the low impedance (0.3 Ω typically) fully integrated switch. The internal loading on this pin is typically less than 10 μA and will increase to 100 μA if V <sub>CC</sub> falls below the voltage on V <sub>AUX</sub> . When V <sub>AUX</sub> = 0 V, the V <sub>CCDES</sub> voltage is inhibited which prevents the regulator from being disabled.
4	GND	GND is the negative reference for all voltages. The current that flows in the ground connection is very low (typically 0.6 mA) and has minimal variation over all load conditions.
5	NC	NC is an unconnected pin which is electrically isolated from the internal circuitry.
6-7	V <sub>OUT</sub>	V <sub>OUT</sub> is the regulator output voltage connection used to power the load. An output capacitor of 4.7 μF is used to provide the necessary phase compensation, thereby preventing oscillation. The capacitor also helps to minimize the peak output disturbance during power supply changeover.
8	DRIVE	DRIVE is a CMOS output logic signal (Active Low) referenced to the V <sub>CC</sub> supply. This output is taken low whenever the internal regulator is not enabled. This output is intended only as a control signal for external circuitry.

# CMPWR101

## SPECIFICATIONS

**Table 2. ABSOLUTE MAXIMUM RATINGS**

Parameter	Rating	Units
ESD Protection (HBM)	±2000	V
Pin Input Voltages V <sub>CC</sub> V <sub>AUX</sub> DRIVE	[GND – 0.5] to +6.0 [GND – 0.5] to +4.0 [GND – 0.5] to [V <sub>CC</sub> + 0.5]	V
Storage Temperature Range	–40 to +150	°C
Operating Temperature Range Ambient Junction	0 to +70 0 to +125	°C
Power Dissipation (Note 1)	0.5	W

Stresses exceeding Maximum Ratings may damage the device. Maximum Ratings are stress ratings only. Functional operation above the Recommended Operating Conditions is not implied. Extended exposure to stresses above the Recommended Operating Conditions may affect device reliability.

- The power rating is based on a printed circuit board heat spreading capability equivalent to 2 square inches of copper connected to the GND pins. Typical multi-layer boards using power plane construction will provide this heat spreading ability without the need for additional dedicated copper area. (Please consult with factory for thermal evaluation assistance).

**Table 3. STANDARD OPERATING CONDITIONS**

Parameter	Rating	Units
V <sub>CC</sub>	5.0 ±0.5	V
V <sub>AUX</sub>	3.3 ±0.3	V
Ambient Operating Temperature Range	0 to +70	°C
Load Current	0 to 250	mA
C <sub>EXT</sub>	4.7 ±20%	µF

**Table 4. ELECTRICAL OPERATING CHARACTERISTICS** (Note 2)

Symbol	Parameter	Conditions	Min	Typ	Max	Units
V <sub>OUT</sub>	Regulator Output Voltage	0 mA < I <sub>LOAD</sub> < 250 mA	3.135	3.300	3.465	V
I <sub>LIM</sub>	Regulator Current Limit		275			mA
V <sub>CCSEL</sub>	V <sub>CC</sub> Select Voltage	Regulator Enabled		4.30	4.45	V
V <sub>CCDES</sub>	V <sub>CC</sub> Deselect Voltage	Regulator Disabled	3.90	4.10		V
V <sub>CCHYST</sub>	Hysteresis Voltage	(Note 3)		0.20		V
V <sub>R LOAD</sub>	Load Regulation	V <sub>CC</sub> = 5 V, 5 mA < I <sub>LOAD</sub> < 250 mA		20		mV
V <sub>R LINE</sub>	Line Regulation	I <sub>LOAD</sub> = 5 mA; 4.5 V < V <sub>CC</sub> < to 5.5 V		2		mV
R <sub>SW</sub>	V <sub>AUX</sub> Switch Resistance	V <sub>CCDES</sub> > V <sub>CC</sub> , V <sub>AUX</sub> = 3.3 V		0.25	0.40	Ω
I <sub>RCC</sub> I <sub>RAUX</sub>	V <sub>CC</sub> Reverse Leakage V <sub>AUX</sub> Reverse Leakage	V <sub>AUX</sub> = 3.3 V, V <sub>CC</sub> = 0 V V <sub>AUX</sub> = 0 V, V <sub>CC</sub> = 5 V		2 2	50 50	µA
I <sub>GND</sub>	Ground Current	V <sub>CC</sub> < V <sub>CCDES</sub> , I <sub>LOAD</sub> = 0 mA V <sub>CC</sub> > V <sub>CCSEL</sub> , I <sub>LOAD</sub> = 0 mA V <sub>CC</sub> > V <sub>CCSEL</sub> , I <sub>LOAD</sub> = 250 mA		0.20 0.60 0.70	0.40 1.00 1.20	mA
I <sub>AUX</sub>	V <sub>AUX</sub> Supply Current	V <sub>AUX</sub> > V <sub>CC</sub> V <sub>CC</sub> > V <sub>AUX</sub>		0.20 0.02	0.40 0.10	mA
R <sub>OH</sub>	DRIVE Pull-up Resistance	R <sub>PULLUP</sub> to V <sub>CC</sub> , V <sub>CC</sub> > V <sub>CCSEL</sub>		4.0	8.0	kΩ
R <sub>OL</sub>	DRIVE Pull-down Resistance	R <sub>PULLDOWN</sub> to GND, V <sub>CCDES</sub> > V <sub>CC</sub>		0.1	0.4	kΩ

- Operating Characteristics are over Standard Operating Conditions unless otherwise specified.
- The hysteresis defines the maximum level of acceptable disturbance on V<sub>CC</sub> during switching. It is recommended that the V<sub>CC</sub> source impedance be kept below 0.25 Ω to ensure the switching disturbance remains below the hysteresis during select/deselect transitions. An input capacitor may be required to help minimize the switching transient.

# CMPWR101

## PERFORMANCE INFORMATION

CMPWR101 Typical DC Characteristics (nominal conditions unless specified otherwise)

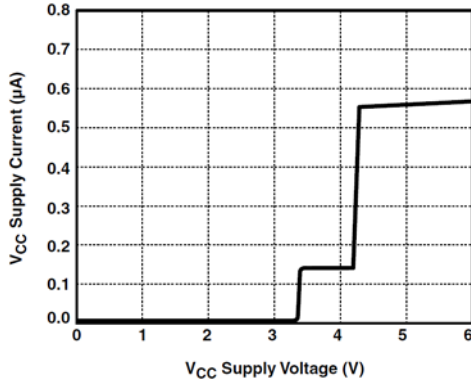

Figure 1. Supply Current vs. Voltage  
(V<sub>AUX</sub> = 3.3 V)

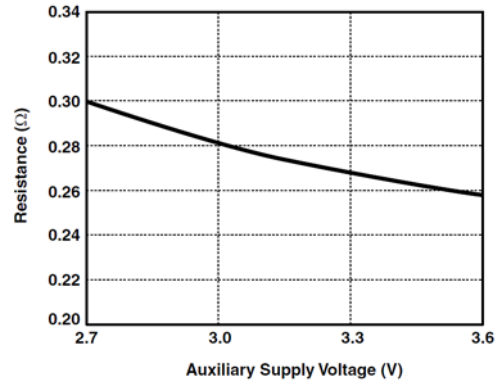

Figure 2. Switch Resistance vs. Supply Voltage

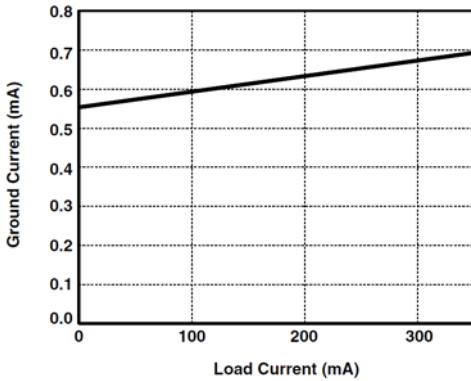

Figure 3. Ground Current vs. Output Load

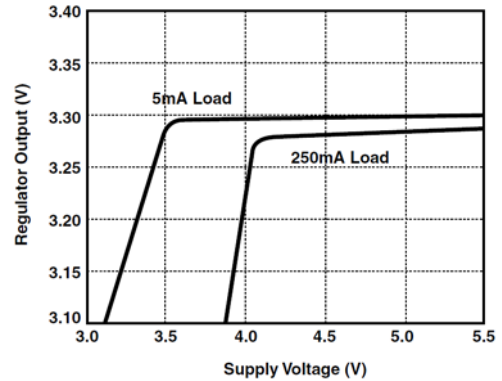

Figure 4. Line Regulation  
(1% and 100% & Rated Load)

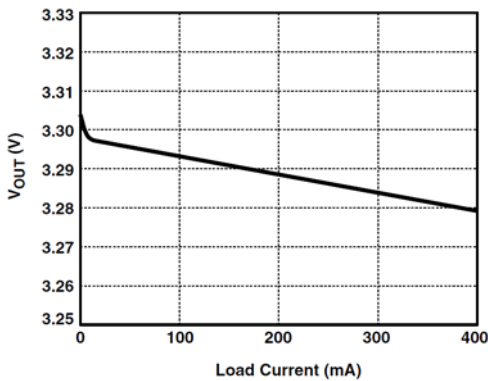

Figure 5. Load Regulation

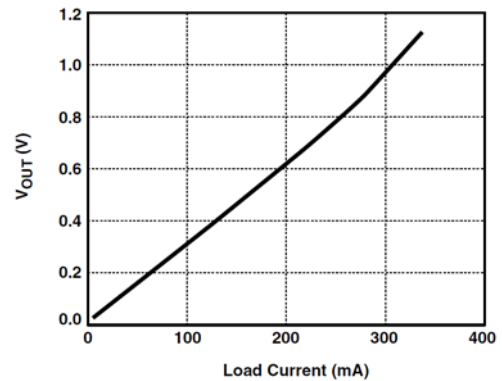
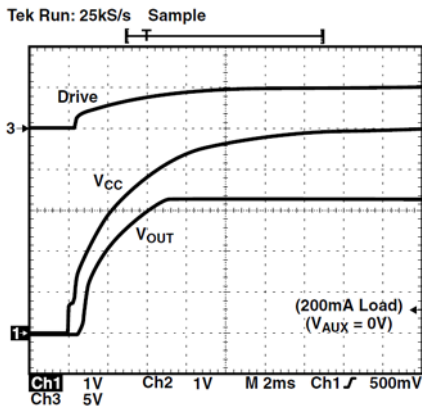

Figure 6. Dropout Voltage with Load Current

# CMPWR101

## PERFORMANCE INFORMATION (Cont'd)

**CMPWR101 Transient Characteristics (nominal conditions unless specified otherwise)**  
 ( $V_{CC}$  source resistance set to 0.2  $\Omega$ )



**Figure 7.  $V_{CC}$  Cold Start Power Up**  
 ( $V_{AUX} = 0V$ )

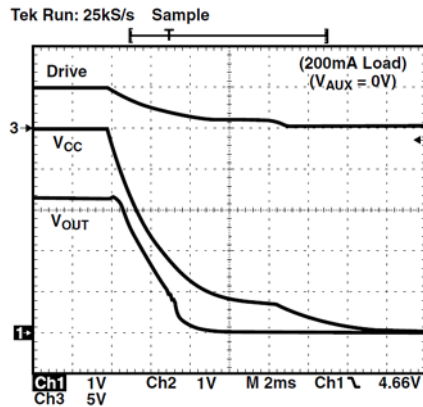

**Figure 8.  $V_{CC}$  Complete Power Down**  
 ( $V_{AUX} = 0V$ )

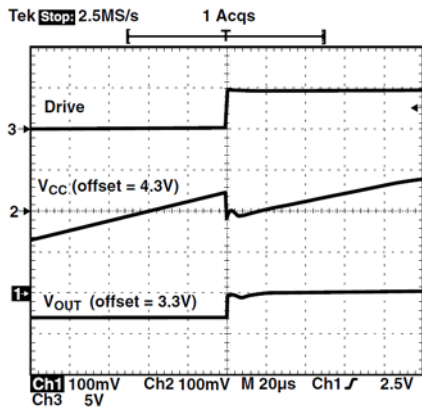

**Figure 9.  $V_{CC}$  Power Up**  
 ( $V_{AUX} = 3.3V$ )

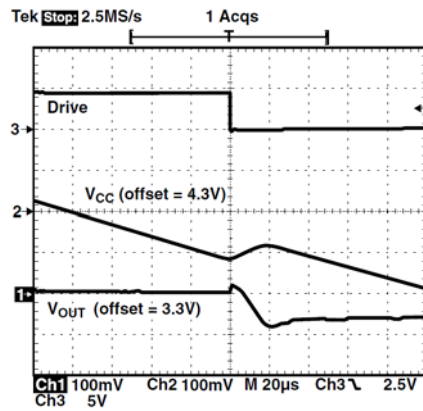

**Figure 10.  $V_{CC}$  Power Down**  
 ( $V_{AUX} = 3.3V$ )

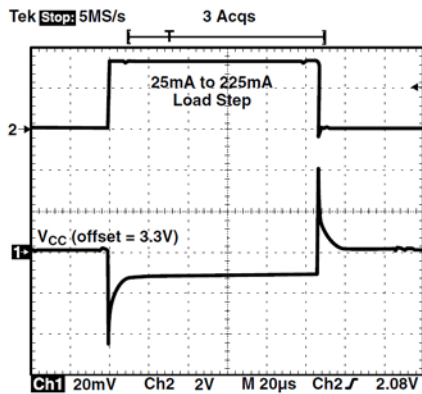

**Figure 11. Load Transient (10% to 90%)  
 Step Response**

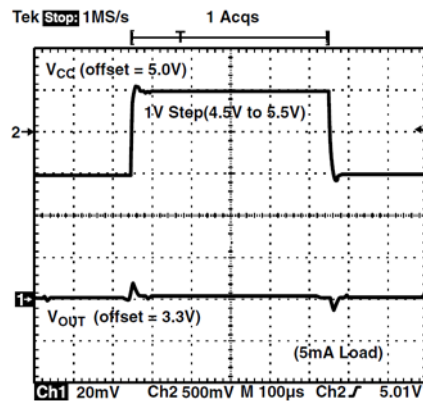

**Figure 12. Line Transient (1V PpP)  
 Step Response**

PERFORMANCE INFORMATION (Cont'd)

**CMPWR101 Typical Thermal Characteristics**

The overall junction to ambient thermal resistance ( $\theta_{JA}$ ) for device power dissipation ( $P_D$ ) consists primarily of two paths in series. The first path is the junction to the case ( $\theta_{JC}$ ) which is defined by the package style, and the second path is case to ambient ( $\theta_{CA}$ ) thermal resistance which is dependent on board layout. The final operating junction temperature for any set of conditions can be estimated by the following thermal equation:

$$\begin{aligned} T_{JUNC} &= T_{AMB} + P_D(\theta_{JC}) + P_D(\theta_{CA}) \\ &= T_{AMB} + P_D(\theta_{JA}) \end{aligned}$$

The CMPWR101 uses a standard SOIC package. When this package is mounted on a double-sided printed circuit board with two square inches of copper allocated for “heat spreading”, the resulting  $\theta_{JA}$  is 85°C/W.

Based on a maximum power dissipation of 0.43 W (1.7 V x 250 mA) with an ambient of 70°C, the resulting junction temperature will be:

$$\begin{aligned} T_{JUNC} &= T_{AMB} + P_D(\theta_{JA}) \\ &= 70^\circ C + 0.4 W (80^\circ C/D) \\ &= 70^\circ C + 37^\circ C = 103^\circ C \end{aligned}$$

Thermal characteristics were measured using a double-sided board with two square inches of copper area connected to the GND pin for “heat spreading”.

Measurements showing performance up to junction temperature of 125°C were performed under light load conditions (5 mA). This allows the ambient temperature to be representative of the internal junction temperature.

**NOTE:** Note: The use of multi-layer board construction with separate ground and power planes will further enhance the overall thermal performance. In the event of no copper area being dedicated for heat spreading, a multi-layer board construction, using only the minimum size pad layout, will provide the CMPWR101 with an overall  $\theta_{JA}$  of 100°C/W which allows up to 500 mW to be safely dissipated.

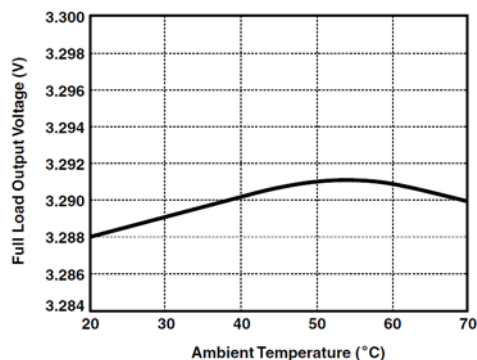

Figure 13. Regulator V<sub>OUT</sub> vs. T<sub>AMB</sub> (250 mA Load)

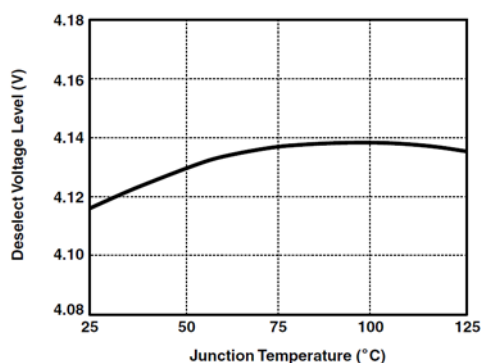

Figure 14. Deselect Threshold vs. T<sub>JUNCT</sub>

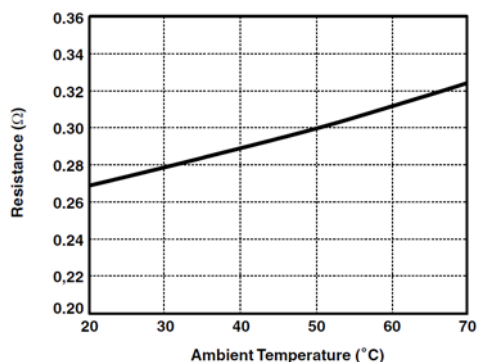
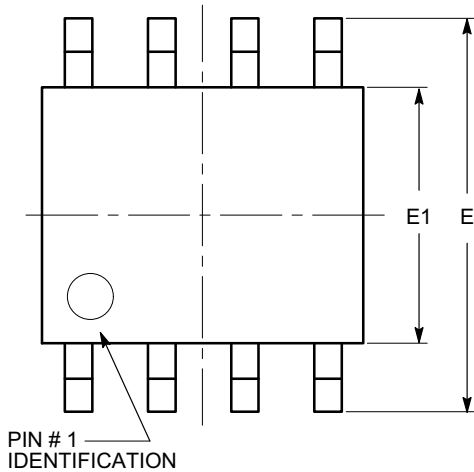

Figure 15. Switch Resistance vs. Ambient Temperature

# CMPWR101

## PACKAGE DIMENSIONS

SOIC 8, 150 mils  
CASE 751BD-01  
ISSUE O



TOP VIEW

SYMBOL	MIN	NOM	MAX
A	1.35		1.75
A1	0.10		0.25
b	0.33		0.51
c	0.19		0.25
D	4.80		5.00
E	5.80		6.20
E1	3.80		4.00
e	1.27 BSC		
h	0.25		0.50
L	0.40		1.27
$\theta$	0°		8°

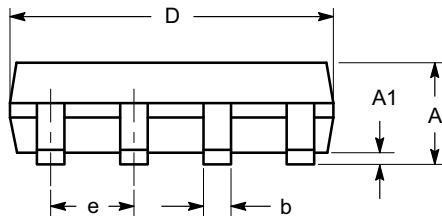

SIDE VIEW

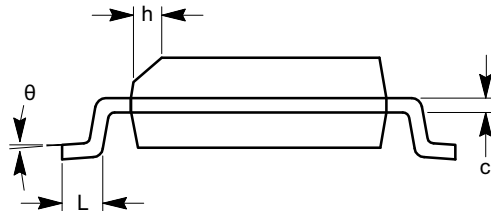

END VIEW

**Notes:**

- (1) All dimensions are in millimeters. Angles in degrees.
- (2) Complies with JEDEC MS-012.

SmartOR is a trademark of Semiconductor Components Industries, LLC (SCILLC).

ON Semiconductor and  are registered trademarks of Semiconductor Components Industries, LLC (SCILLC). SCILLC reserves the right to make changes without further notice to any products herein. SCILLC makes no warranty, representation or guarantee regarding the suitability of its products for any particular purpose, nor does SCILLC assume any liability arising out of the application or use of any product or circuit, and specifically disclaims any and all liability, including without limitation special, consequential or incidental damages. "Typical" parameters which may be provided in SCILLC data sheets and/or specifications can and do vary in different applications and actual performance may vary over time. All operating parameters, including "Typicals" must be validated for each customer application by customer's technical experts. SCILLC does not convey any license under its patent rights nor the rights of others. SCILLC products are not designed, intended, or authorized for use as components in systems intended for surgical implant into the body, or other applications intended to support or sustain life, or for any other application in which the failure of the SCILLC product could create a situation where personal injury or death may occur. Should Buyer purchase or use SCILLC products for any such unintended or unauthorized application, Buyer shall indemnify and hold SCILLC and its officers, employees, subsidiaries, affiliates, and distributors harmless against all claims, costs, damages, and expenses, and reasonable attorney fees arising out of, directly or indirectly, any claim of personal injury or death associated with such unintended or unauthorized use, even if such claim alleges that SCILLC was negligent regarding the design or manufacture of the part. SCILLC is an Equal Opportunity/Affirmative Action Employer. This literature is subject to all applicable copyright laws and is not for resale in any manner.

**PUBLICATION ORDERING INFORMATION**

**LITERATURE FULFILLMENT:**  
Literature Distribution Center for ON Semiconductor  
P.O. Box 5163, Denver, Colorado 80217 USA  
**Phone:** 303-675-2175 or 800-344-3860 Toll Free USA/Canada  
**Fax:** 303-675-2176 or 800-344-3867 Toll Free USA/Canada  
**Email:** orderlit@onsemi.com

**N. American Technical Support:** 800-282-9855 Toll Free USA/Canada  
**Europe, Middle East and Africa Technical Support:**  
Phone: 421 33 790 2910  
**Japan Customer Focus Center**  
Phone: 81-3-5773-3850

**ON Semiconductor Website:** [www.onsemi.com](http://www.onsemi.com)  
**Order Literature:** <http://www.onsemi.com/orderlit>  
For additional information, please contact your local Sales Representative