

TPS22906 Ultra-Small, Low-Input Voltage, Low r_{ON} Load Switch

1 Features

- Low-Input Voltage: 1.0 V to 3.6 V
- Ultra-Low ON-State Resistance
 - $r_{ON} = 90 \text{ m}\Omega$ at $V_{IN} = 3.6 \text{ V}$
 - $r_{ON} = 100 \text{ m}\Omega$ at $V_{IN} = 2.5 \text{ V}$
 - $r_{ON} = 114 \text{ m}\Omega$ at $V_{IN} = 1.8 \text{ V}$
 - $r_{ON} = 172 \text{ m}\Omega$ at $V_{IN} = 1.2 \text{ V}$
- 500-mA Maximum Continuous Switch Current
- Ultra-Low Quiescent Current: 82 nA at 1.8 V
- Ultra-Low Shutdown Current: 44 nA at 1.8 V
- Low Control Input Thresholds Enable Use of 1.2-V/1.8-V/2.5-V/3.3-V Logic
- Controlled Slew Rate to Avoid Inrush Current: $220 \mu\text{s } t_r$
- ESD Performance Tested Per JESD 22
 - 2000-V Human Body Model (A114-B, Class II)
 - 1000-V Charged-Device Model (C101)
- Four-Terminal Wafer-Chip-Scale Package (WCSP)
 - 0.9 mm × 0.9 mm,
0.5-mm Pitch, 0.5-mm Height

2 Applications

- Personal Digital Assistants (PDAs)
- Cellular Phones
- GPS Devices
- MP3 Players
- Digital Cameras
- Peripheral Ports
- Portable Instrumentation
- RF Modules

3 Description

TPS22906 device is an ultra-small, low ON-state resistance (r_{ON}) load switch with controlled turn on. The device contains a P-channel MOSFET that operates over an input voltage range of 1.0 V to 3.6 V. The switch is controlled by an on/off input (ON), which is capable of interfacing directly with low-voltage control signals. A 120- Ω on-chip load resistor is added for output quick discharge when the switch is turned off. TPS22906 is available in a space-saving 4-terminal WCSP with 0.5-mm pitch (YZV). The device is characterized for operation over the free-air temperature range of -40°C to 85°C .

Device Information⁽¹⁾

PART NUMBER	PACKAGE	BODY SIZE (NOM)
TPS22906	DSBGA (4)	0.90 mm × 0.90 mm

(1) For all available packages, see the orderable addendum at the end of the data sheet.

Typical Application Schematic

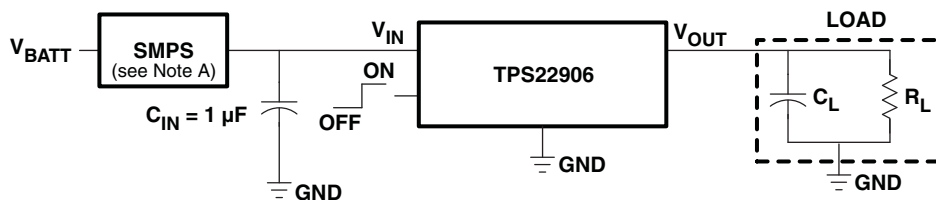

Table of Contents

1	Features	1	8	Parameter Measurement Information	13
2	Applications	1	9	Detailed Description	14
3	Description	1	9.1	Overview	14
4	Revision History	2	9.2	Functional Block Diagram	14
5	Device Options	3	9.3	Feature Description	14
6	Pin Configuration and Functions	3	9.4	Device Functional Modes	14
7	Specifications	3	10	Application and Implementation	15
7.1	Absolute Maximum Ratings	3	10.1	Application Information	15
7.2	ESD Ratings	4	10.2	Typical Application	15
7.3	Recommended Operating Conditions	4	11	Power Supply Recommendations	17
7.4	Thermal Information	4	12	Layout	17
7.5	Electrical Characteristics	4	12.1	Layout Guidelines	17
7.6	Switching Characteristics – $V_{IN} = 1.1\text{ V}$	5	12.2	Layout Example	17
7.7	Switching Characteristics – $V_{IN} = 1.2\text{ V}$	5	13	Device and Documentation Support	18
7.8	Switching Characteristics – $V_{IN} = 1.8\text{ V}$	6	13.1	Community Resources	18
7.9	Switching Characteristics – $V_{IN} = 2.5\text{ V}$	6	13.2	Trademarks	18
7.10	Switching Characteristics – $V_{IN} = 3\text{ V}$	6	13.3	Electrostatic Discharge Caution	18
7.11	Switching Characteristics – $V_{IN} = 3.6\text{ V}$	7	13.4	Glossary	18
7.12	Typical Characteristics	8	14	Mechanical, Packaging, and Orderable Information	18

4 Revision History

NOTE: Page numbers for previous revisions may differ from page numbers in the current version.

Changes from Original (March 2009) to Revision A

Page

- Added *Pin Configuration and Functions* section, *ESD Ratings* table, *Feature Description* section, *Device Functional Modes*, *Application and Implementation* section, *Power Supply Recommendations* section, *Layout* section, *Device and Documentation Support* section, and *Mechanical, Packaging, and Orderable Information* section **1**
- Deleted Ordering Information table. **1**

5 Device Options

DEVICE	r_{ON} at 1.8 V (TYP)	SLEW RATE (TYP at 1.8 V)	QUICK OUTPUT DISCHARGE ⁽¹⁾	MAX OUTPUT CURRENT	ENABLE
TPS22906	114 m Ω	220 μ s	Yes	500 mA	Active high

(1) This feature discharges the output of the switch to ground through a 120- Ω resistor, preventing the output from floating.

6 Pin Configuration and Functions

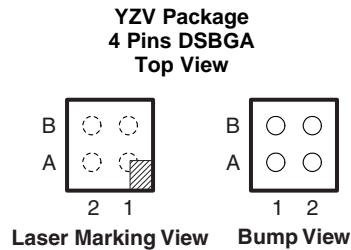

Pin Assignments

B	ON	GND
A	V_{IN}	V_{OUT}
	2	1

Pin Functions

PIN		I/O	DESCRIPTION
NAME	NO.		
V_{OUT}	A1	O	Switch output
V_{IN}	A2	I	Switch input, bypass this input with a ceramic capacitor to ground
GND	B1	—	Ground
ON	B2	I	Switch control input, active high

7 Specifications

7.1 Absolute Maximum Ratings

over operating free-air temperature range (unless otherwise noted)⁽¹⁾

		MIN	MAX	UNIT
V_{IN}	Input voltage	-0.3	4	V
V_{OUT}	Output voltage		$V_{IN} + 0.3$	V
V_{ON}	Input voltage	-0.3	4	V
P_D	Power dissipation at $T_A = 25^\circ\text{C}$		0.48	W
I_{MAX}	Maximum continuous switch current		500	mA
T_A	Operating free-air temperature range	-40	85	$^\circ\text{C}$
	Maximum lead temperature (10-s soldering time), T_{lead}		300	$^\circ\text{C}$
	Storage temperature, T_{stg}	-45	150	$^\circ\text{C}$

(1) Stresses beyond those listed under *Absolute Maximum Ratings* may cause permanent damage to the device. These are stress ratings only, which do not imply functional operation of the device at these or any other conditions beyond those indicated under *Recommended Operating Conditions*. Exposure to absolute-maximum-rated conditions for extended periods may affect device reliability.

7.2 ESD Ratings

		VALUE	UNIT
$V_{(ESD)}$ Electrostatic discharge	Human body model (HBM), per ANSI/ESDA/JEDEC JS-001 ⁽¹⁾	±2000	V
	Charged-device model (CDM), per JEDEC specification JESD22-C101 ⁽²⁾	±1000	

(1) JEDEC document JEP155 states that 500-V HBM allows safe manufacturing with a standard ESD control process.

(2) JEDEC document JEP157 states that 250-V CDM allows safe manufacturing with a standard ESD control process.

7.3 Recommended Operating Conditions

over operating free-air temperature range (unless otherwise noted)

		MIN	MAX	UNIT
V_{IN}	Input voltage range	1	3.6	V
V_{OUT}	Output voltage range		V_{IN}	V
V_{IH}	High-level input voltage, ON	0.85	3.6	V
V_{IL}	Low-level input voltage, ON		0.4	V
C_{IN}	Input capacitor	1		μF

7.4 Thermal Information

THERMAL METRIC ⁽¹⁾		TPS2206		UNIT
		YZV (DSBGA)		
		4 PINS		
$R_{\theta JA}$	Junction-to-ambient thermal resistance	189.1		°C/W
$R_{\theta JC(top)}$	Junction-to-case (top) thermal resistance	1.9		°C/W
$R_{\theta JB}$	Junction-to-board thermal resistance	36.8		°C/W
Ψ_{JT}	Junction-to-top characterization parameter	11.3		°C/W
Ψ_{JB}	Junction-to-board characterization parameter	36.8		°C/W
$R_{\theta JC(bot)}$	Junction-to-case (bottom) thermal resistance	—		°C/W

(1) For more information about traditional and new thermal metrics, see the *Semiconductor and IC Package Thermal Metrics* application report, [SPRA953](#).

7.5 Electrical Characteristics

$V_{IN} = 1.0\text{ V to }3.6\text{ V}$, $T_A = -40^\circ\text{C to }85^\circ\text{C}$ (unless otherwise noted)

PARAMETER	TEST CONDITIONS	T_A	MIN		TYP		MAX		UNIT
I_{IN}	Quiescent current $I_{OUT} = 0$, $V_{IN} = V_{ON}$	Full				37	120	nA	
							82		235
							204		880
$I_{IN(OFF)}$	OFF-state supply current $V_{ON} = \text{GND}$, $\text{OUT} = \text{Open}$	Full				22	210	nA	
							44		260
							137		700
$I_{IN(LEAKAGE)}$	OFF-state switch current $V_{ON} = \text{GND}$, $V_{OUT} = 0$	Full				22	140	nA	
							45		230
							137		610

Electrical Characteristics (continued)

 $V_{IN} = 1.0\text{ V to }3.6\text{ V}$, $T_A = -40^\circ\text{C to }85^\circ\text{C}$ (unless otherwise noted)

PARAMETER		TEST CONDITIONS		T_A	MIN	TYP	MAX	UNIT		
r_{ON}	ON-state resistance	$I_{OUT} = -200\text{ mA}$	$V_{IN} = 3.6\text{ V}$	25°C	90	108	mΩ			
				Full	125					
			$V_{IN} = 2.5\text{ V}$	25°C	100	120				
				Full	140					
			$V_{IN} = 1.8\text{ V}$	25°C	114	138				
				Full	160					
			$V_{IN} = 1.2\text{ V}$	25°C	172	210				
				Full	235					
			$V_{IN} = 1.1\text{ V}$	25°C	204	330				
				Full	330					
			r_{PD}	Output pulldown resistance	$V_{IN} = 3.3\text{ V}$, $V_{ON} = 0$, $I_{OUT} = 30\text{ mA}$	25°C		88	120	Ω
			I_{ON}	ON input leakage current	$V_{ON} = 1.1\text{ V to }3.6\text{ V or GND}$	Full			25	nA

7.6 Switching Characteristics – $V_{IN} = 1.1\text{ V}$

 $T_A = 25^\circ\text{C}$, $R_{L_CHIP} = 120\text{ Ω}$ (unless otherwise noted)

PARAMETER		TEST CONDITIONS		MIN	TYP	MAX	UNIT
t_{ON}	Turnon time	$R_L = 500\text{ Ω}$	$C_L = 0.1\text{ μF}$		531	μs	
			$C_L = 1\text{ μF}$		596		
			$C_L = 3.3\text{ μF}$		659		
t_{OFF}	Turnoff time	$R_L = 500\text{ Ω}$	$C_L = 0.1\text{ μF}$		11	μs	
			$C_L = 1\text{ μF}$		67		
			$C_L = 3.3\text{ μF}$		225		
t_r	V_{OUT} rise time	$R_L = 500\text{ Ω}$	$C_L = 0.1\text{ μF}$		365	μs	
			$C_L = 1\text{ μF}$		367		
			$C_L = 3.3\text{ μF}$		395		
t_f	V_{OUT} fall time	$R_L = 500\text{ Ω}$	$C_L = 0.1\text{ μF}$		21	μs	
			$C_L = 1\text{ μF}$		189		
			$C_L = 3.3\text{ μF}$		565		

7.7 Switching Characteristics – $V_{IN} = 1.2\text{ V}$

 $T_A = 25^\circ\text{C}$, $R_{L_CHIP} = 120\text{ Ω}$ (unless otherwise noted)

PARAMETER		TEST CONDITIONS		MIN	TYP	MAX	UNIT
t_{ON}	Turnon time	$R_L = 500\text{ Ω}$	$C_L = 0.1\text{ μF}$		471	μs	
			$C_L = 1\text{ μF}$		527		
			$C_L = 3.3\text{ μF}$		587		
t_{OFF}	Turnoff time	$R_L = 500\text{ Ω}$	$C_L = 0.1\text{ μF}$		10	μs	
			$C_L = 1\text{ μF}$		61		
			$C_L = 3.3\text{ μF}$		199		
t_r	V_{OUT} rise time	$R_L = 500\text{ Ω}$	$C_L = 0.1\text{ μF}$		324	μs	
			$C_L = 1\text{ μF}$		325		
			$C_L = 3.3\text{ μF}$		350		
t_f	V_{OUT} fall time	$R_L = 500\text{ Ω}$	$C_L = 0.1\text{ μF}$		20	μs	
			$C_L = 1\text{ μF}$		175		
			$C_L = 3.3\text{ μF}$		523		

7.8 Switching Characteristics – $V_{IN} = 1.8\text{ V}$

 $T_A = 25^\circ\text{C}$, $R_{L_CHIP} = 120\ \Omega$ (unless otherwise noted)

PARAMETER		TEST CONDITIONS		MIN	TYP	MAX	UNIT
t_{ON}	Turnon time	$R_L = 500\ \Omega$	$C_L = 0.1\ \mu\text{F}$		302		μs
			$C_L = 1\ \mu\text{F}$		335		
			$C_L = 3.3\ \mu\text{F}$		367		
t_{OFF}	Turnoff time	$R_L = 500\ \Omega$	$C_L = 0.1\ \mu\text{F}$		8		μs
			$C_L = 1\ \mu\text{F}$		49		
			$C_L = 3.3\ \mu\text{F}$		167		
t_r	V_{OUT} rise time	$R_L = 500\ \Omega$	$C_L = 0.1\ \mu\text{F}$		220		μs
			$C_L = 1\ \mu\text{F}$		220		
			$C_L = 3.3\ \mu\text{F}$		235		
t_f	V_{OUT} fall time	$R_L = 500\ \Omega$	$C_L = 0.1\ \mu\text{F}$		15		μs
			$C_L = 1\ \mu\text{F}$		159		
			$C_L = 3.3\ \mu\text{F}$		481		

7.9 Switching Characteristics – $V_{IN} = 2.5\text{ V}$

 $T_A = 25^\circ\text{C}$, $R_{L_CHIP} = 120\ \Omega$ (unless otherwise noted)

PARAMETER		TEST CONDITIONS		MIN	TYP	MAX	UNIT
t_{ON}	Turnon time	$R_L = 500\ \Omega$	$C_L = 0.1\ \mu\text{F}$		223		μs
			$C_L = 1\ \mu\text{F}$		246		
			$C_L = 3.3\ \mu\text{F}$		268		
t_{OFF}	Turnoff time	$R_L = 500\ \Omega$	$C_L = 0.1\ \mu\text{F}$		7		μs
			$C_L = 1\ \mu\text{F}$		47		
			$C_L = 3.3\ \mu\text{F}$		158		
t_r	V_{OUT} rise time	$R_L = 500\ \Omega$	$C_L = 0.1\ \mu\text{F}$		175		μs
			$C_L = 1\ \mu\text{F}$		175		
			$C_L = 3.3\ \mu\text{F}$		187		
t_f	V_{OUT} fall time	$R_L = 500\ \Omega$	$C_L = 0.1\ \mu\text{F}$		18		μs
			$C_L = 1\ \mu\text{F}$		185		
			$C_L = 3.3\ \mu\text{F}$		471		

7.10 Switching Characteristics – $V_{IN} = 3\text{ V}$

 $T_A = 25^\circ\text{C}$, $R_{L_CHIP} = 120\ \Omega$ (unless otherwise noted)

PARAMETER		TEST CONDITIONS		MIN	TYP	MAX	UNIT
t_{ON}	Turnon time	$R_L = 500\ \Omega$	$C_L = 0.1\ \mu\text{F}$		191		μs
			$C_L = 1\ \mu\text{F}$		211		
			$C_L = 3.3\ \mu\text{F}$		231		
t_{OFF}	Turnoff time	$R_L = 500\ \Omega$	$C_L = 0.1\ \mu\text{F}$		7		μs
			$C_L = 1\ \mu\text{F}$		46		
			$C_L = 3.3\ \mu\text{F}$		156		
t_r	V_{OUT} rise time	$R_L = 500\ \Omega$	$C_L = 0.1\ \mu\text{F}$		159		μs
			$C_L = 1\ \mu\text{F}$		160		
			$C_L = 3.3\ \mu\text{F}$		170		
t_f	V_{OUT} fall time	$R_L = 500\ \Omega$	$C_L = 0.1\ \mu\text{F}$		17		μs
			$C_L = 1\ \mu\text{F}$		160		
			$C_L = 3.3\ \mu\text{F}$		473		

7.11 Switching Characteristics – $V_{IN} = 3.6\text{ V}$

 $T_A = 25^\circ\text{C}$, $R_{L_CHIP} = 120\ \Omega$ (unless otherwise noted)

PARAMETER		TEST CONDITIONS		MIN	TYP	MAX	UNIT
t_{ON}	Turnon time	$R_L = 500\ \Omega$	$C_L = 0.1\ \mu\text{F}$		166		μs
			$C_L = 1\ \mu\text{F}$		183		
			$C_L = 3.3\ \mu\text{F}$		201		
t_{OFF}	Turnoff time	$R_L = 500\ \Omega$	$C_L = 0.1\ \mu\text{F}$		7		μs
			$C_L = 1\ \mu\text{F}$		45		
			$C_L = 3.3\ \mu\text{F}$		155		
t_r	V_{OUT} rise time	$R_L = 500\ \Omega$	$C_L = 0.1\ \mu\text{F}$		146		μs
			$C_L = 1\ \mu\text{F}$		146		
			$C_L = 3.3\ \mu\text{F}$		156		
t_f	V_{OUT} fall time	$R_L = 500\ \Omega$	$C_L = 0.1\ \mu\text{F}$		17		μs
			$C_L = 1\ \mu\text{F}$		161		
			$C_L = 3.3\ \mu\text{F}$		475		

7.12 Typical Characteristics

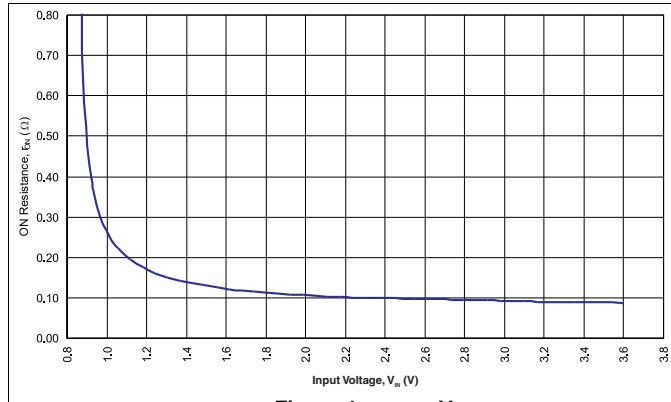

Figure 1. r_{ON} vs V_{IN}

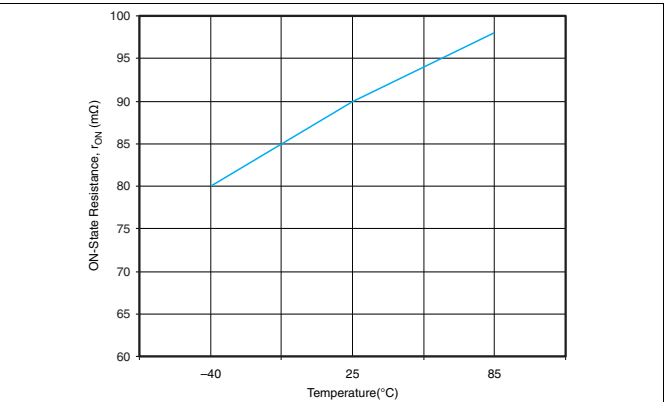

Figure 2. r_{ON} vs Temperature ($V_{IN} = 3.3\text{ V}$)

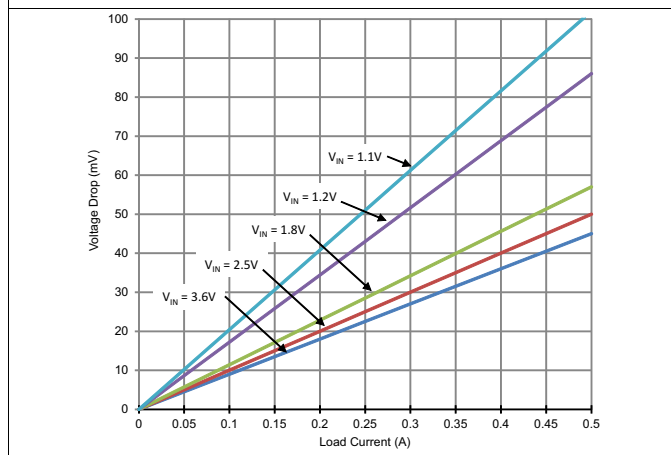

Figure 3. Voltage Drop vs Load Current

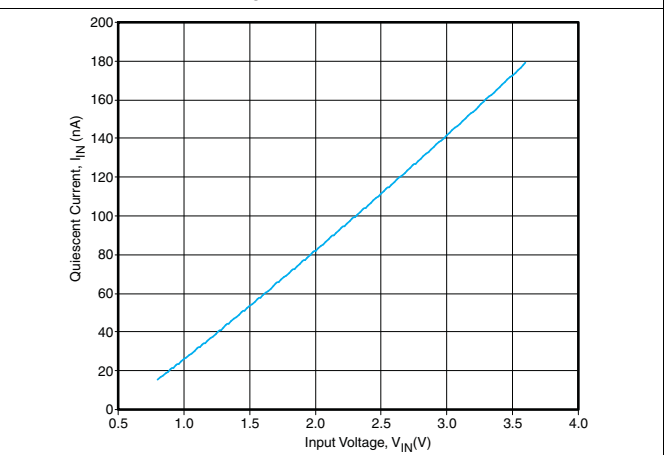

Figure 4. Quiescent Current vs V_{IN} ($V_{ON} = V_{IN}$, $I_{OUT} = 0$)

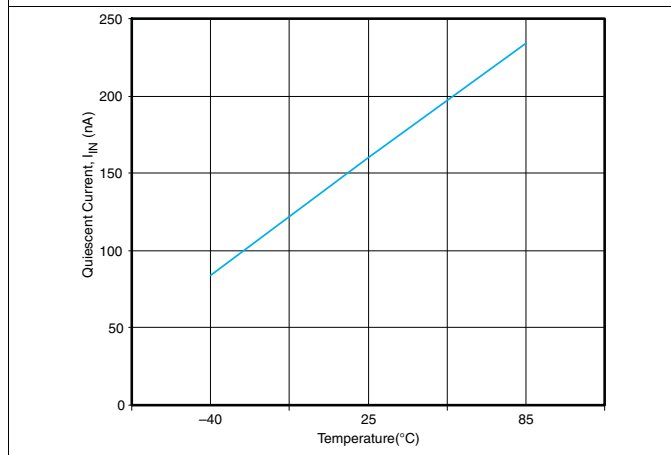

Figure 5. Quiescent Current vs Temperature ($V_{IN} = 3.3\text{ V}$, $I_{OUT} = 0$)

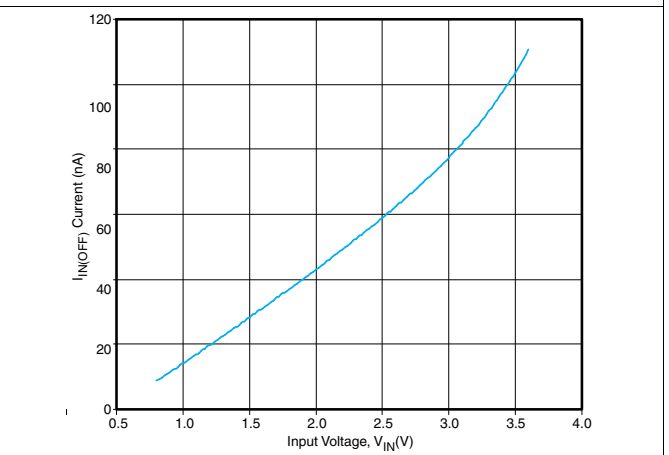

Figure 6. $I_{IN(OFF)}$ vs V_{IN} ($V_{ON} = 0\text{ V}$)

Typical Characteristics (continued)

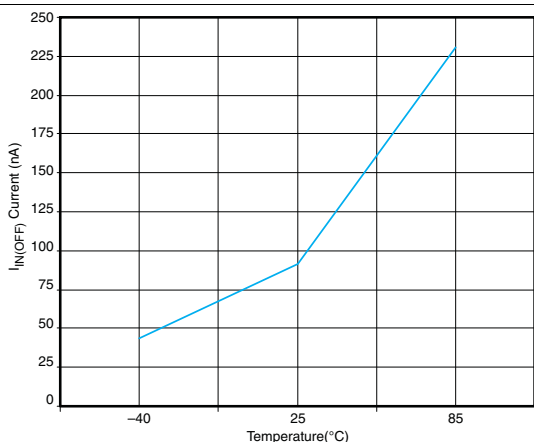

Figure 7. $I_{IN(OFF)}$ vs Temperature ($V_{IN} = 3.3\text{ V}$)

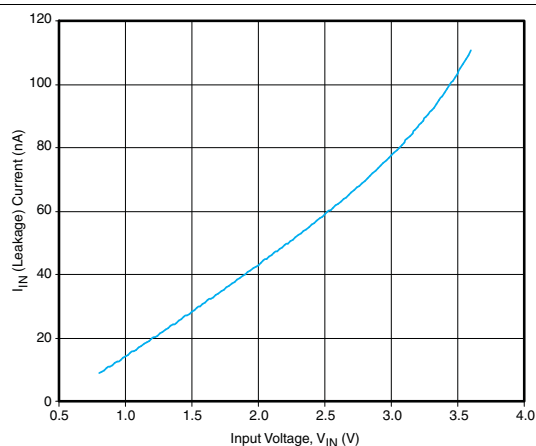

Figure 8. $I_{IN(Leakage)}$ vs V_{IN} ($I_{OUT} = 0$)

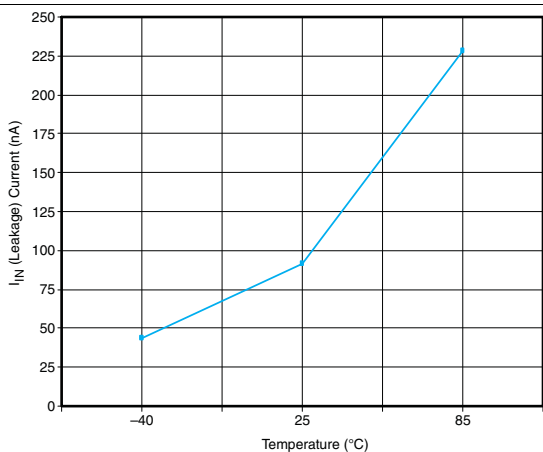

Figure 9. $I_{IN(Leakage)}$ vs Temperature ($V_{IN} = 3.3\text{ V}$)

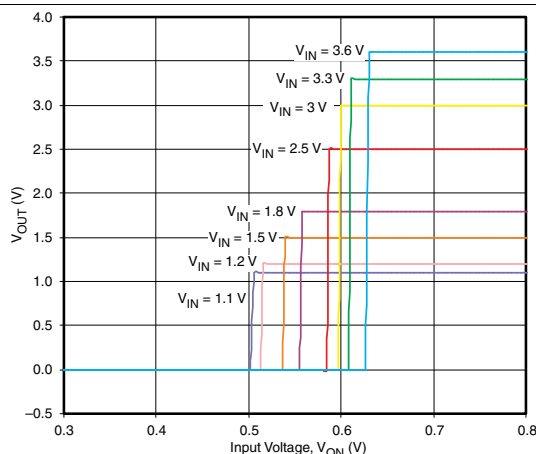

Figure 10. ON-Input Threshold

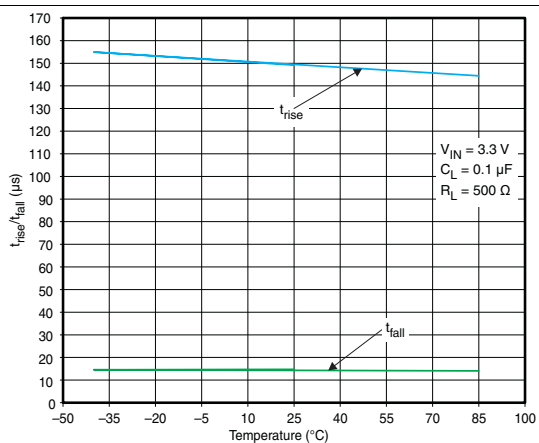

Figure 11. t_{rise}/t_{fall} vs Temperature

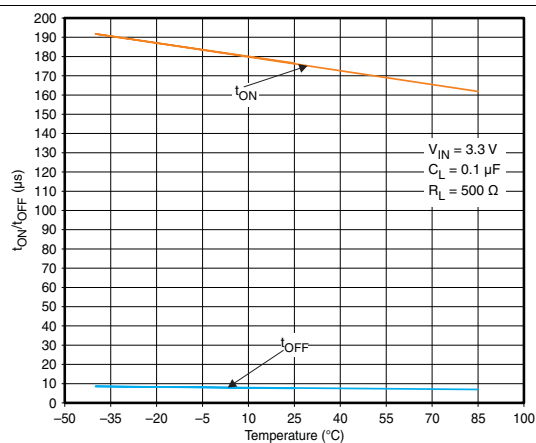
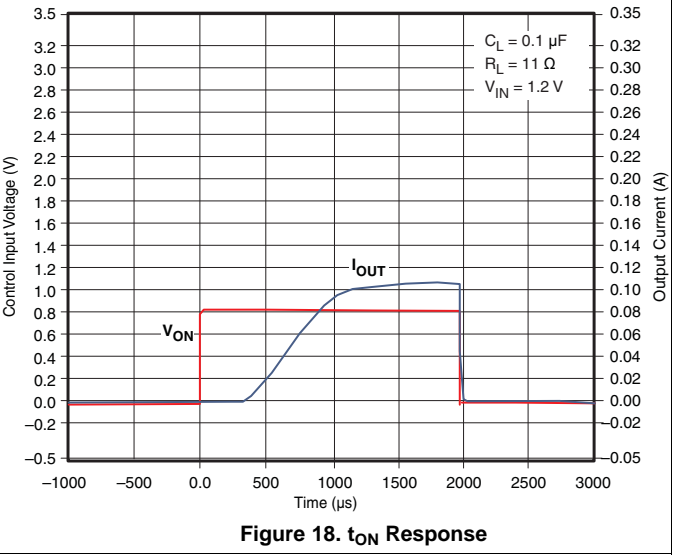
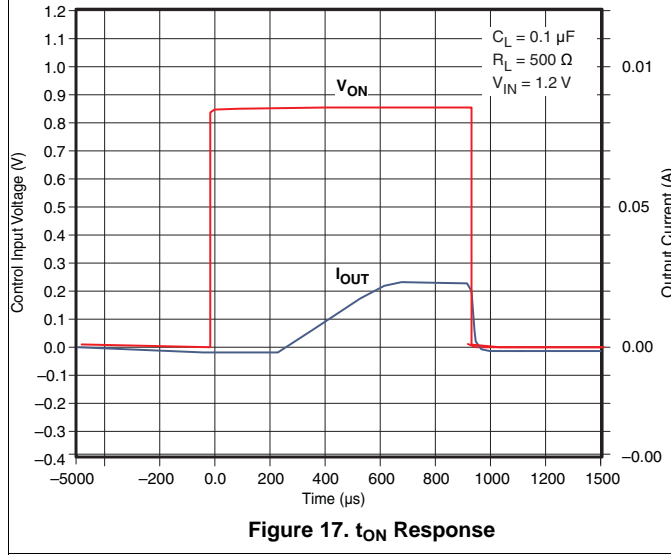
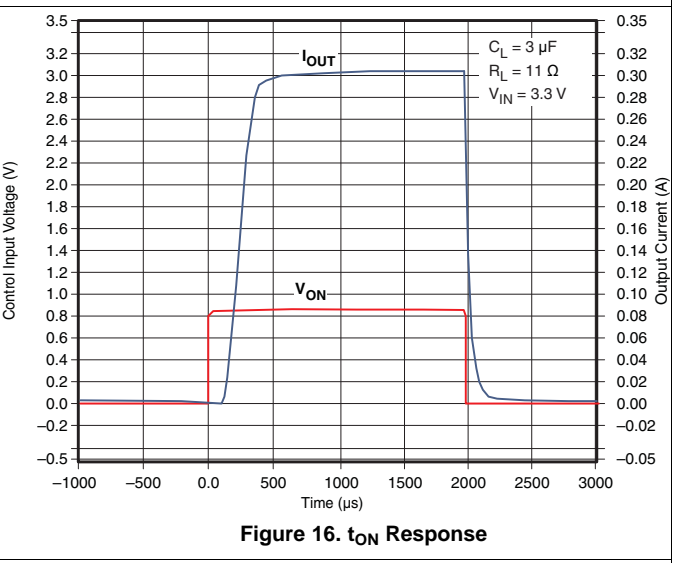
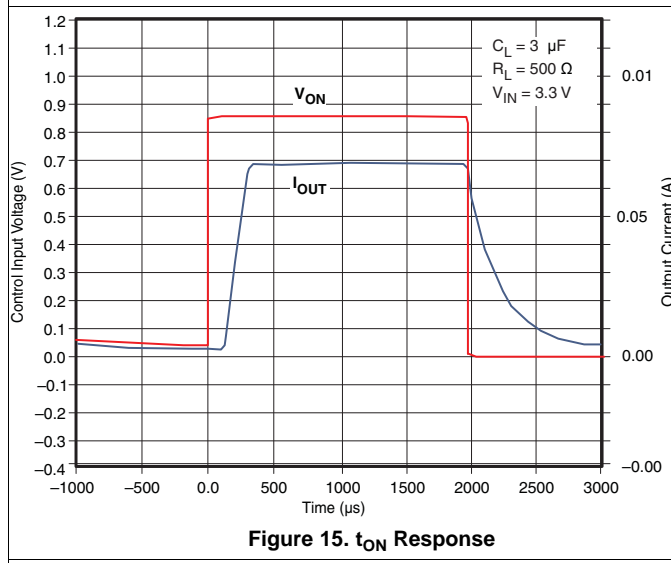
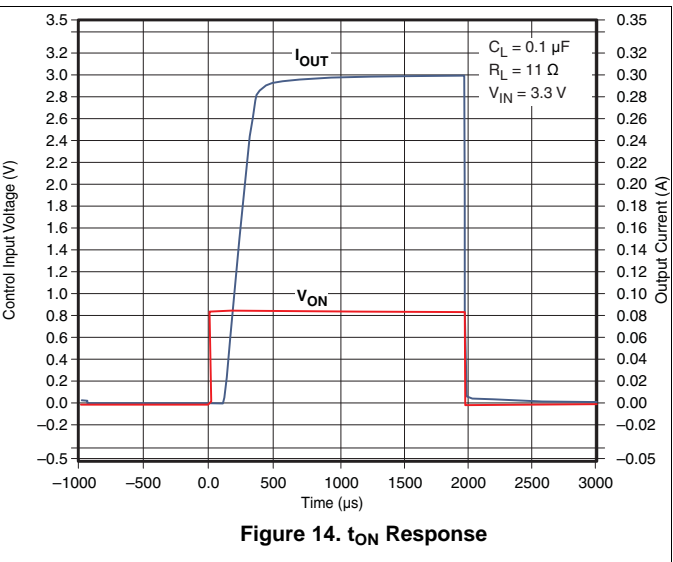
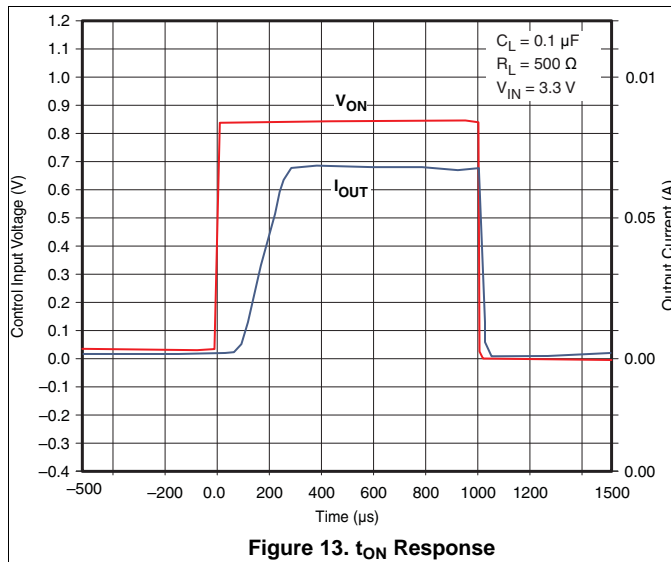

Figure 12. t_{ON}/t_{OFF} vs Temperature

Typical Characteristics (continued)



Typical Characteristics (continued)

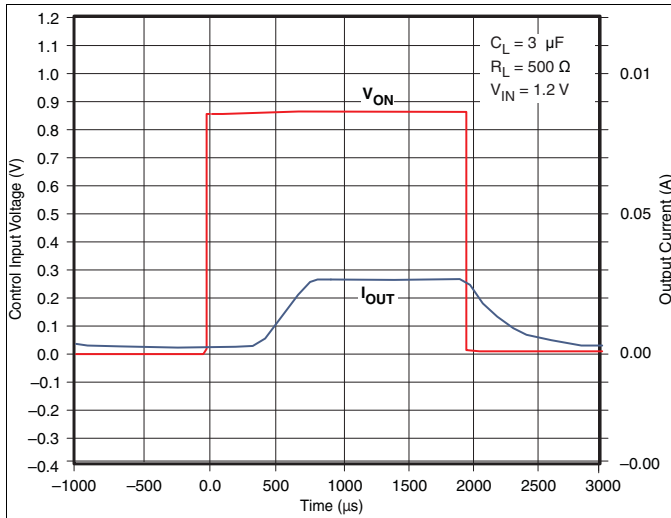

Figure 19. t_{ON} Response

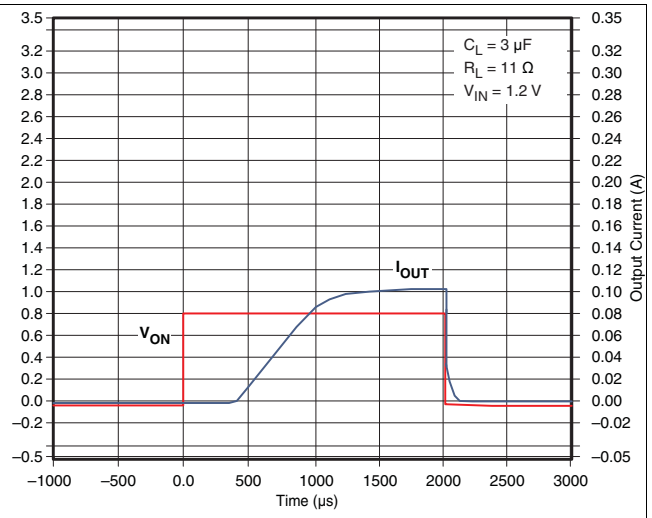

Figure 20. t_{ON} Response

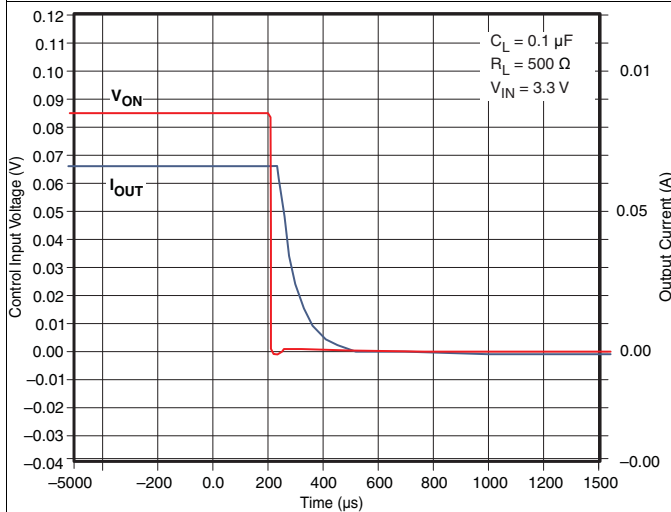

Figure 21. t_{OFF} Response

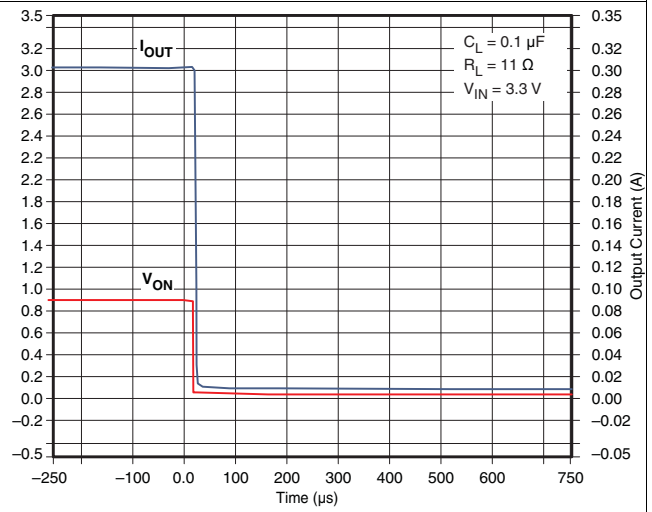

Figure 22. t_{OFF} Response

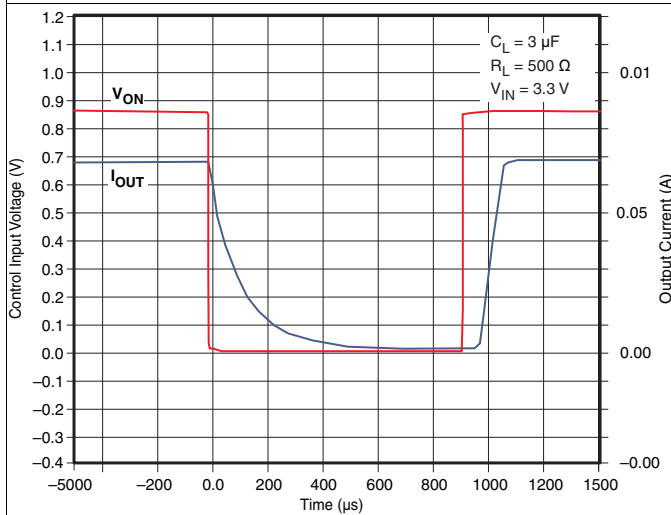

Figure 23. t_{OFF} Response

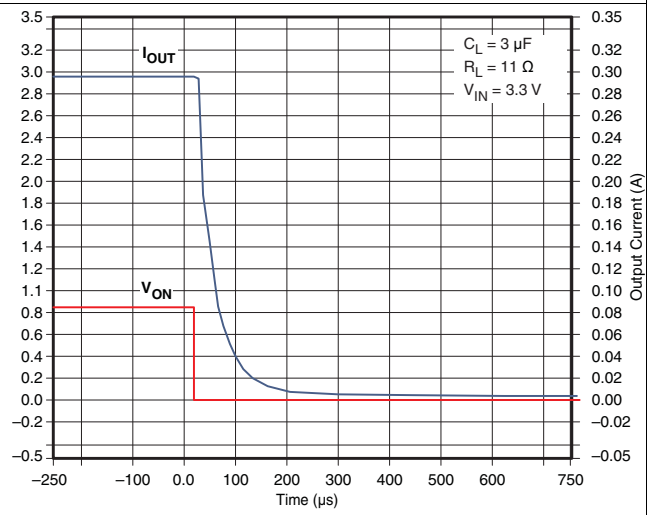

Figure 24. t_{OFF} Response

Typical Characteristics (continued)

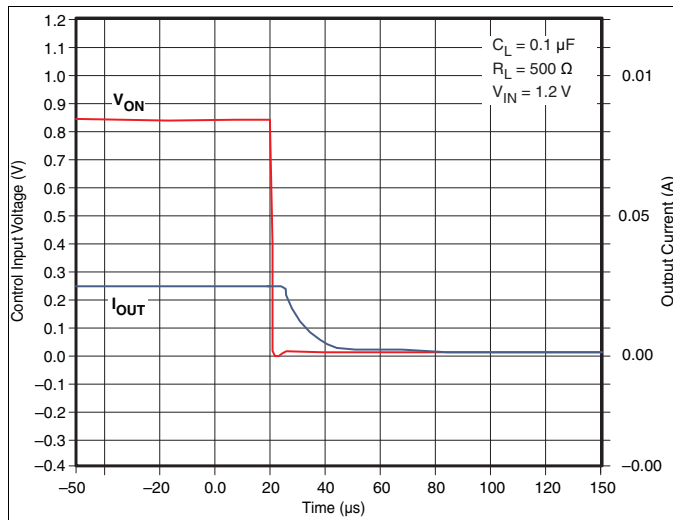

Figure 25. t_{OFF} Response

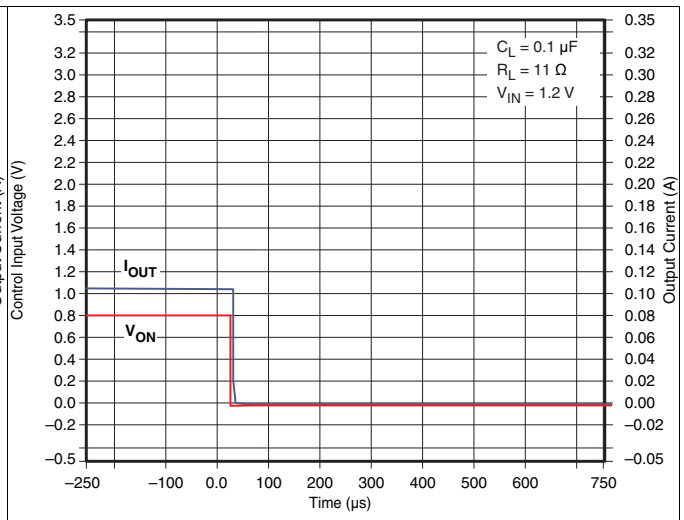

Figure 26. t_{OFF} Response

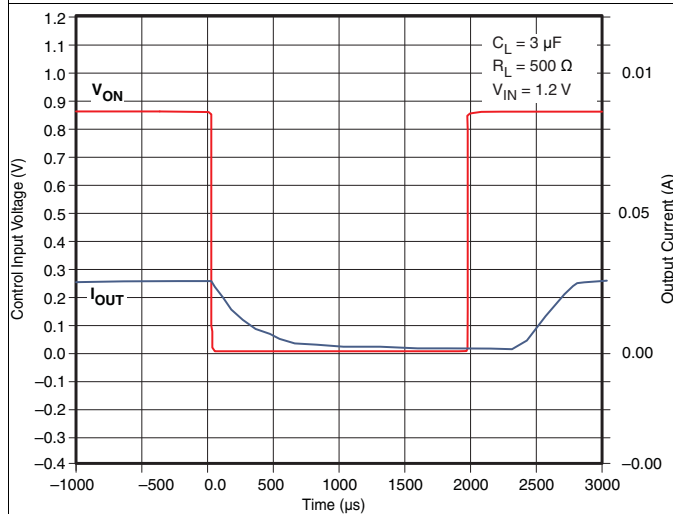

Figure 27. t_{OFF} Response

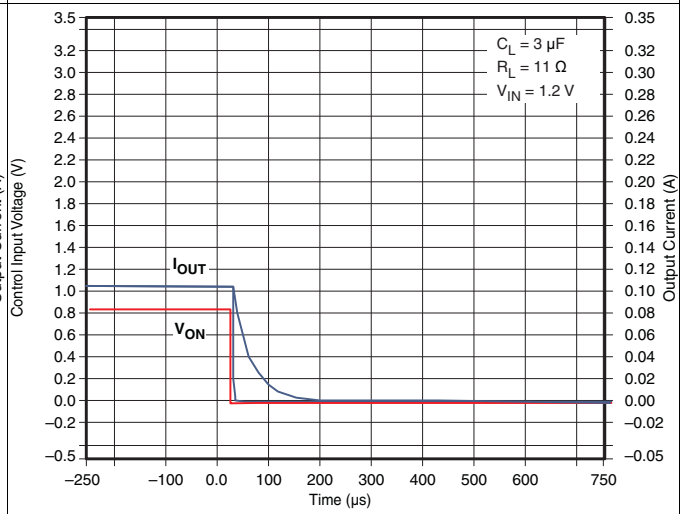
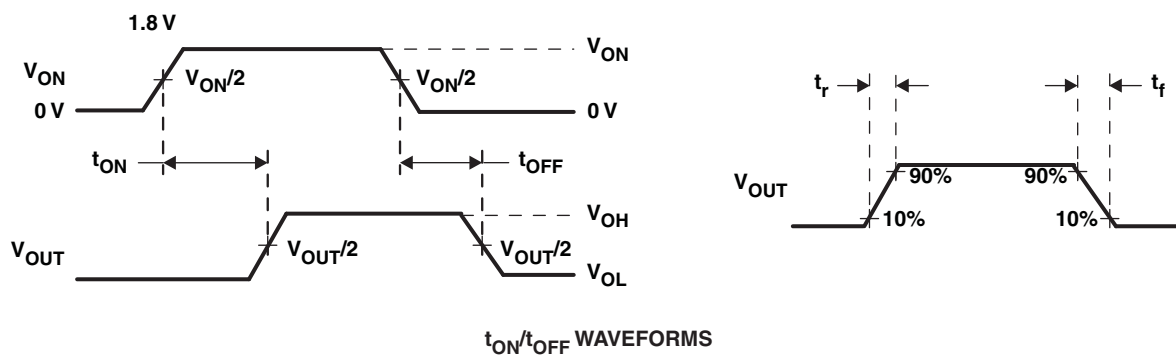
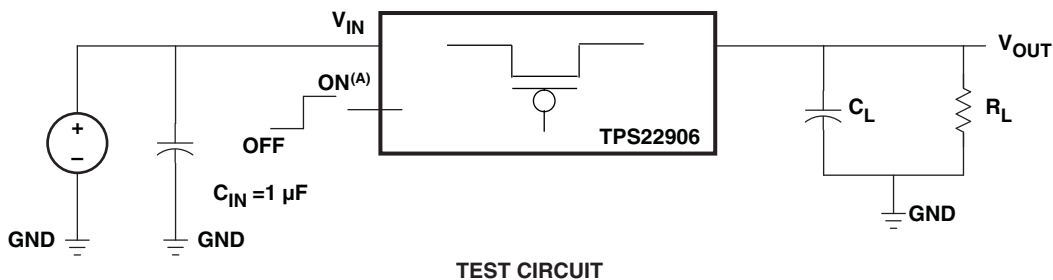

Figure 28. t_{OFF} Response

8 Parameter Measurement Information



A. t_{rise} and t_{fall} of the control signal is 100 ns.

Figure 29. Test Circuit and t_{ON}/t_{OFF} Waveforms

9 Detailed Description

9.1 Overview

TPS22906 is a low ON-state resistance (r_{ON}) load switch with controlled turnon. The device contains a P-channel MOSFET that operates over an input voltage range of 1.0 V to 3.6 V. The switch is controlled by an on/off input (ON), which is capable of interfacing directly with low-voltage control signals. A 120- Ω on-chip load resistor is added for output quick discharge when the switch is turned off.

9.2 Functional Block Diagram

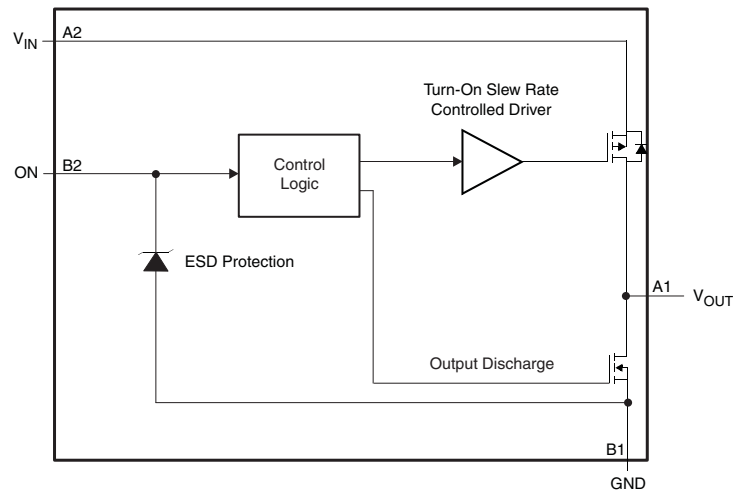

9.3 Feature Description

9.3.1 ON/OFF Control

The ON pin controls the state of the switch. Activating ON continuously holds the switch in the on state so long as there is no fault. ON is active HI and has a low threshold making it capable of interfacing with low-voltage signals. The ON pin is compatible with standard GPIO logic threshold. It can be used with any microcontroller with 1.2-V, 1.8-V, 2.5-V, or 3.3-V GPIOs.

9.4 Device Functional Modes

Table 1 lists the functional modes of the TPS22906.

Table 1. Function Table

ON (CONTROL INPUT)	V_{IN} TO V_{OUT}	V_{OUT} TO GND
L	OFF	ON
H	ON	OFF

10 Application and Implementation

NOTE

Information in the following applications sections is not part of the TI component specification, and TI does not warrant its accuracy or completeness. TI's customers are responsible for determining suitability of components for their purposes. Customers should validate and test their design implementation to confirm system functionality.

10.1 Application Information

10.1.1 Input Capacitor

To limit the voltage drop on the input supply caused by transient in-rush currents when the switch turns on into a discharged load capacitor or short-circuit, a capacitor needs to be placed between V_{IN} and GND. A 1- μ F ceramic capacitor, C_{IN} , placed close to the pins is usually sufficient. Higher values of C_{IN} can be used to further reduce the voltage drop during high current application. When switching heavy loads, it is recommended to have an input capacitor approximately 10 times higher than the output capacitor to avoid excessive voltage drop.

10.1.2 Output Capacitor

Due to the integral body diode in the PMOS switch, a C_{IN} greater than C_L is highly recommended. A C_L greater than C_{IN} can cause V_{OUT} to exceed V_{IN} when the system supply is removed. This could result in current flow through the body diode from V_{OUT} to V_{IN} .

10.2 Typical Application

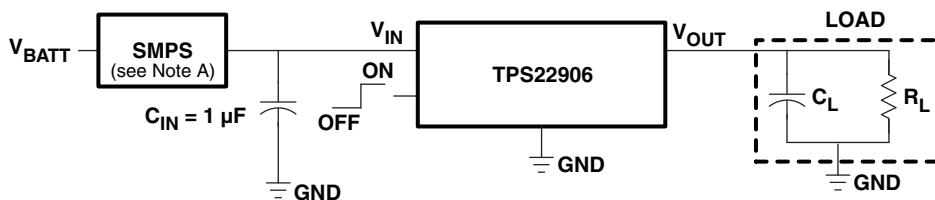

A. Switched mode power supply

Figure 30. Powering a Downstream Module

10.2.1 Design Requirements

Table 2 lists the design parameters for the TPS22906 device.

Table 2. Design Parameters

DESIGN PARAMETER	EXAMPLE VALUE
V_{IN}	1.8 V
Load Current	0.3 A
Ambient Temperature	25°C

10.2.2 Detailed Design Procedure

10.2.2.1 V_{IN} to V_{OUT} Voltage Drop

The voltage drop from V_{IN} to V_{OUT} is determined by the ON-resistance of the device and the load current. The r_{ON} can be found in [Electrical Characteristics](#) and is dependent on temperature. When the value of r_{ON} is found, [Equation 1](#) can be used to calculate the voltage drop across the device:

$$\Delta V = I_{LOAD} \times r_{ON}$$

where

- ΔV = Voltage drop across the device
- I_{LOAD} = Load current

- r_{ON} = ON-resistance of the device (1)

At $V_{IN} = 1.8\text{ V}$, the TPS22906 has a r_{ON} value of $114\text{ m}\Omega$. Using this value and the defined load current, the above equation can be evaluated:

$$\Delta V = 0.30\text{ A} \times 114\text{ m}\Omega$$

where

- $\Delta V = 34\text{ mV}$ (2)

Therefore, the voltage drop across the device will be 34 mV .

10.2.3 Application Curve

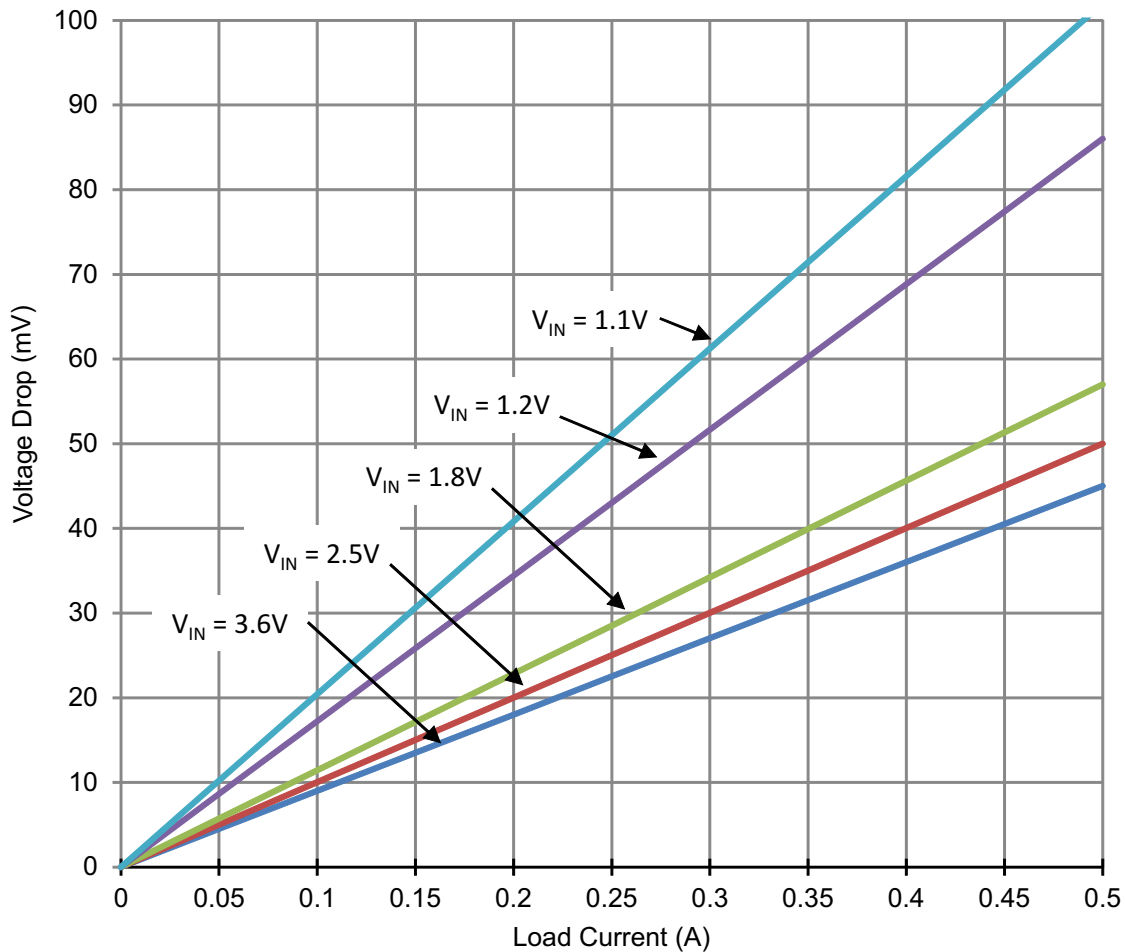

Figure 31. Voltage Drop Vs Load Current

11 Power Supply Recommendations

The device is designed to operate with a V_{IN} range of 1.1 V to 3.6 V. This supply must be well regulated and placed as close to the device terminals as possible. It must also be able to withstand all transient and load currents, using a recommended input capacitance of 1 μF if necessary. If the supply is more than a few inches from the device terminals, additional bulk capacitance may be required in addition to the ceramic bypass capacitors. If additional bulk capacitance is required, an electrolytic, tantalum, or ceramic capacitor of 10 μF may be sufficient.

12 Layout

12.1 Layout Guidelines

For best performance, all traces should be as short as possible. To be most effective, the input and output capacitors should be placed close to the device to minimize the effects that parasitic trace inductances may have on normal and short circuit operation. Using wide traces for V_{IN} , V_{OUT} , and GND helps minimize the parasitic electrical effects along with minimizing the case to ambient thermal impedance.

12.2 Layout Example

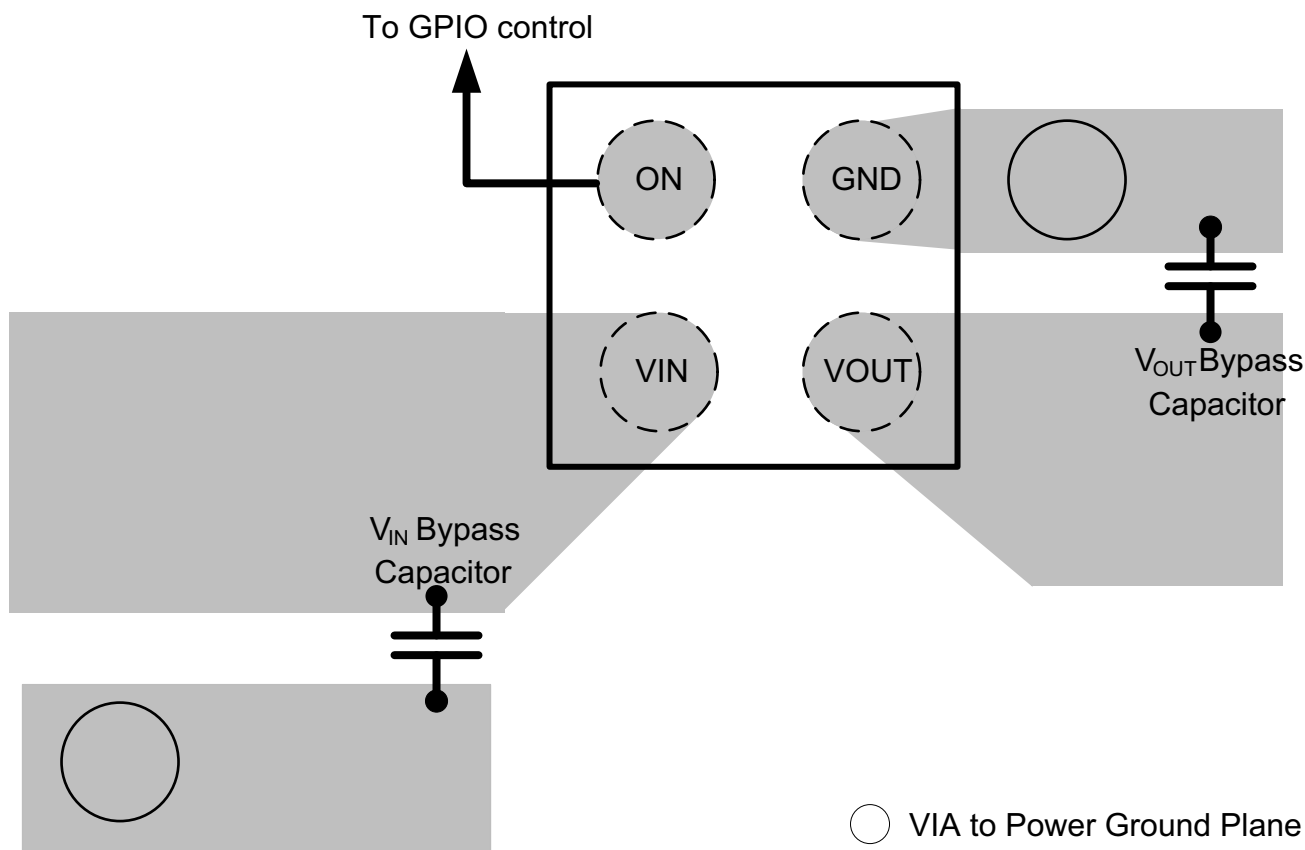

Figure 32. Recommended Board Layout

13 Device and Documentation Support

13.1 Community Resources

The following links connect to TI community resources. Linked contents are provided "AS IS" by the respective contributors. They do not constitute TI specifications and do not necessarily reflect TI's views; see TI's [Terms of Use](#).

TI E2E™ Online Community *TI's Engineer-to-Engineer (E2E) Community*. Created to foster collaboration among engineers. At e2e.ti.com, you can ask questions, share knowledge, explore ideas and help solve problems with fellow engineers.

Design Support *TI's Design Support* Quickly find helpful E2E forums along with design support tools and contact information for technical support.

13.2 Trademarks

E2E is a trademark of Texas Instruments.

13.3 Electrostatic Discharge Caution



These devices have limited built-in ESD protection. The leads should be shorted together or the device placed in conductive foam during storage or handling to prevent electrostatic damage to the MOS gates.

13.4 Glossary

[SLYZ022](#) — *TI Glossary*.

This glossary lists and explains terms, acronyms, and definitions.

14 Mechanical, Packaging, and Orderable Information

The following pages include mechanical, packaging, and orderable information. This information is the most current data available for the designated devices. This data is subject to change without notice and revision of this document. For browser-based versions of this data sheet, refer to the left-hand navigation.

PACKAGING INFORMATION

Orderable Device	Status (1)	Package Type	Package Drawing	Pins	Package Qty	Eco Plan (2)	Lead finish/ Ball material (6)	MSL Peak Temp (3)	Op Temp (°C)	Device Marking (4/5)	Samples
TPS22906YZVR	NRND	DSBGA	YZV	4	3000	RoHS & Green	SNAGCU	Level-1-260C-UNLIM	-40 to 85	5D (3, 5)	

(1) The marketing status values are defined as follows:

ACTIVE: Product device recommended for new designs.

LIFEBUY: TI has announced that the device will be discontinued, and a lifetime-buy period is in effect.

NRND: Not recommended for new designs. Device is in production to support existing customers, but TI does not recommend using this part in a new design.

PREVIEW: Device has been announced but is not in production. Samples may or may not be available.

OBSELETE: TI has discontinued the production of the device.

(2) **RoHS:** TI defines "RoHS" to mean semiconductor products that are compliant with the current EU RoHS requirements for all 10 RoHS substances, including the requirement that RoHS substance do not exceed 0.1% by weight in homogeneous materials. Where designed to be soldered at high temperatures, "RoHS" products are suitable for use in specified lead-free processes. TI may reference these types of products as "Pb-Free".

RoHS Exempt: TI defines "RoHS Exempt" to mean products that contain lead but are compliant with EU RoHS pursuant to a specific EU RoHS exemption.

Green: TI defines "Green" to mean the content of Chlorine (Cl) and Bromine (Br) based flame retardants meet JS709B low halogen requirements of <=1000ppm threshold. Antimony trioxide based flame retardants must also meet the <=1000ppm threshold requirement.

(3) MSL, Peak Temp. - The Moisture Sensitivity Level rating according to the JEDEC industry standard classifications, and peak solder temperature.

(4) There may be additional marking, which relates to the logo, the lot trace code information, or the environmental category on the device.

(5) Multiple Device Markings will be inside parentheses. Only one Device Marking contained in parentheses and separated by a "~" will appear on a device. If a line is indented then it is a continuation of the previous line and the two combined represent the entire Device Marking for that device.

(6) Lead finish/Ball material - Orderable Devices may have multiple material finish options. Finish options are separated by a vertical ruled line. Lead finish/Ball material values may wrap to two lines if the finish value exceeds the maximum column width.

Important Information and Disclaimer:The information provided on this page represents TI's knowledge and belief as of the date that it is provided. TI bases its knowledge and belief on information provided by third parties, and makes no representation or warranty as to the accuracy of such information. Efforts are underway to better integrate information from third parties. TI has taken and continues to take reasonable steps to provide representative and accurate information but may not have conducted destructive testing or chemical analysis on incoming materials and chemicals. TI and TI suppliers consider certain information to be proprietary, and thus CAS numbers and other limited information may not be available for release.

In no event shall TI's liability arising out of such information exceed the total purchase price of the TI part(s) at issue in this document sold by TI to Customer on an annual basis.

TAPE AND REEL INFORMATION



QUADRANT ASSIGNMENTS FOR PIN 1 ORIENTATION IN TAPE



*All dimensions are nominal

Device	Package Type	Package Drawing	Pins	SPQ	Reel Diameter (mm)	Reel Width W1 (mm)	A0 (mm)	B0 (mm)	K0 (mm)	P1 (mm)	W (mm)	Pin1 Quadrant
TPS22906YZVR	DSBGA	YZV	4	3000	178.0	9.2	1.0	1.0	0.63	4.0	8.0	Q1

TAPE AND REEL BOX DIMENSIONS



*All dimensions are nominal

Device	Package Type	Package Drawing	Pins	SPQ	Length (mm)	Width (mm)	Height (mm)
TPS22906YZVR	DSBGA	YZV	4	3000	220.0	220.0	35.0

YZV (S-XBGA-N4)

DIE-SIZE BALL GRID ARRAY

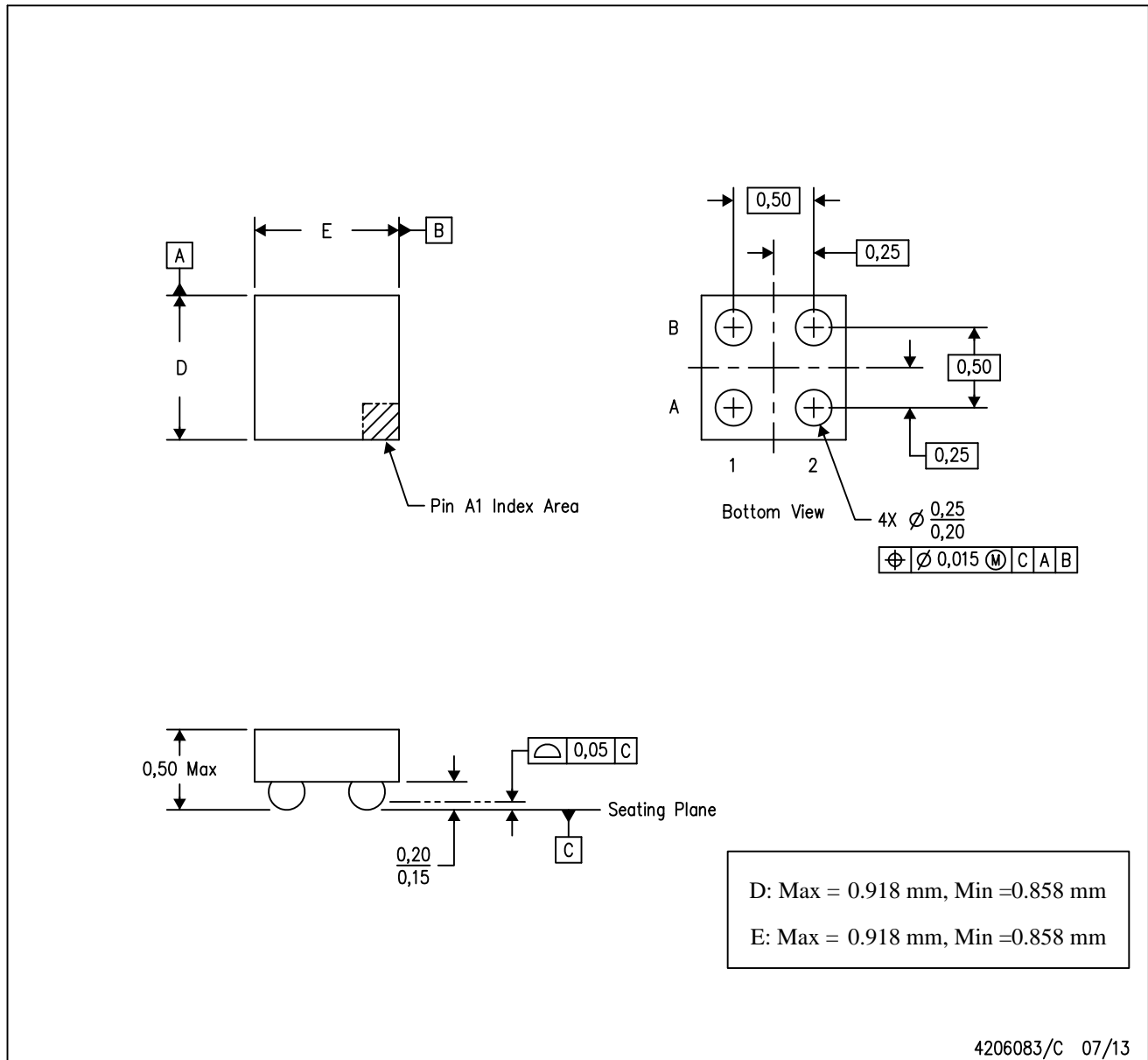

- NOTES:
- A. All linear dimensions are in millimeters. Dimensioning and tolerancing per ASME Y14.5M-1994.
 - B. This drawing is subject to change without notice.
 - C. NanoFree™ package configuration.

NanoFree is a trademark of Texas Instruments.

IMPORTANT NOTICE AND DISCLAIMER

TI PROVIDES TECHNICAL AND RELIABILITY DATA (INCLUDING DATASHEETS), DESIGN RESOURCES (INCLUDING REFERENCE DESIGNS), APPLICATION OR OTHER DESIGN ADVICE, WEB TOOLS, SAFETY INFORMATION, AND OTHER RESOURCES "AS IS" AND WITH ALL FAULTS, AND DISCLAIMS ALL WARRANTIES, EXPRESS AND IMPLIED, INCLUDING WITHOUT LIMITATION ANY IMPLIED WARRANTIES OF MERCHANTABILITY, FITNESS FOR A PARTICULAR PURPOSE OR NON-INFRINGEMENT OF THIRD PARTY INTELLECTUAL PROPERTY RIGHTS.

These resources are intended for skilled developers designing with TI products. You are solely responsible for (1) selecting the appropriate TI products for your application, (2) designing, validating and testing your application, and (3) ensuring your application meets applicable standards, and any other safety, security, or other requirements. These resources are subject to change without notice. TI grants you permission to use these resources only for development of an application that uses the TI products described in the resource. Other reproduction and display of these resources is prohibited. No license is granted to any other TI intellectual property right or to any third party intellectual property right. TI disclaims responsibility for, and you will fully indemnify TI and its representatives against, any claims, damages, costs, losses, and liabilities arising out of your use of these resources.

TI's products are provided subject to TI's Terms of Sale (www.ti.com/legal/termsofsale.html) or other applicable terms available either on ti.com or provided in conjunction with such TI products. TI's provision of these resources does not expand or otherwise alter TI's applicable warranties or warranty disclaimers for TI products.

Mailing Address: Texas Instruments, Post Office Box 655303, Dallas, Texas 75265
Copyright © 2020, Texas Instruments Incorporated