

Powerex, Inc., 200 Hillis Street, Youngwood, Pennsylvania 15697-1800 (412) 925-7272  
 Powerex, Europe, S.A. 428 Avenue G. Durand, BP107, 72003 Le Mans, France (43) 41.14.14

**Phase Control SCR**  
 2300 Amperes Average  
 2500 Volts

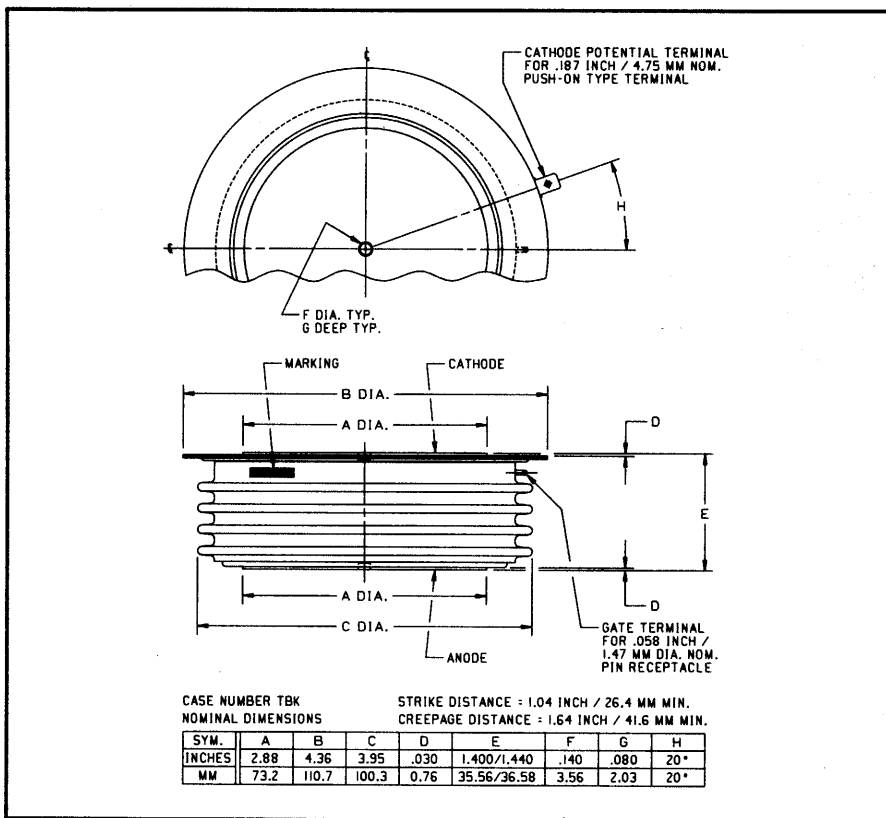

C782 (Outline Drawing)



**C782 Phase Control SCR**  
 2300 Amperes Average, 2500 Volts

### Ordering Information:

Select the complete six digit part number you desire from the table, i.e. C782LE is a 2500 Volt, 2300 Ampere Phase Control SCR.

Type	Voltage		Current
	$V_{DRM}$	Code	$I_{T(av)}$
C782	2200	LB	2300
	2300	LC	
	2400	LD	
	2500	LE	

### Description:

Powerex Silicon Controlled Rectifiers (SCR) are designed for phase control applications. These are all-diffused, Press-Pak, hermetic Pow-R-Disc devices employing the field proven amplifying gate.

### Features:

- Low On-State Voltage
- High di/dt Capability
- High dv/dt Capability
- Hermetic Packaging
- Excellent Surge and  $I^2t$  Ratings

### Applications:

- Power Supplies
- Motor Control



Powerex, Inc., 200 Hillis Street, Youngwood, Pennsylvania 15697-1800 (412) 925-7272  
 Powerex, Europe, S.A. 428 Avenue G. Durand, BP107, 72003 Le Mans, France (43) 41.14.14

**C782**  
**Phase Control SCR**  
 2300 Amperes Average, 2500 Volts

### Absolute Maximum Ratings

Characteristics	Symbol	C782	Units
Non-repetitive Transient Peak Reverse Voltage	$V_{RSM}$	$V_{RRM} + 100V$	Volts
RMS On-state Current, $T_C = 70^\circ C$	$I_{T(rms)}$	3610	Amperes
Average Current 180° Sine Wave, $T_C = 70^\circ C$	$I_{T(av)}$	2300	Amperes
RMS On-state Current, $T_C = 55^\circ C$	$I_{T(rms)}$	4240	Amperes
Average Current 180° Sine Wave, $T_C = 55^\circ C$	$I_{T(av)}$	2700	Amperes
Peak One Cycle Surge On-state Current (Non-repetitive) 60Hz	$I_{tsm}$	35000	Amperes
Peak One Cycle Surge On-state Current (Non-repetitive) 50Hz	$I_{tsm}$	32000	Amperes
Critical Rate-of-rise of On-state Current (Non-repetitive)	di/dt	600	A/ $\mu$ sec
Critical Rate-of-rise of On-state Current (Repetitive)	di/dt	100	A/ $\mu$ sec
$I^2t$ (for Fusing) for One Cycle, 60Hz	$I^2t$	$5 \times 10^6$	$A^2$ sec
Peak Gate Power Dissipation	$P_{GM}$	250	Watts
Average Gate Power Dissipation	$P_{G(av)}$	35	Watts
Operating Temperature	$T_j$	-40 to +125°C	°C
Storage Temperature	$T_{stg}$	-40 to +150°C	°C
Approximate Weight		3.5	lb.
		1.60	kg
Mounting Force		9000 to 10000	lb.
		40 to 44.5	kN

**C782**

**Phase Control SCR**

2300 Amperes Average, 2500 Volts

**Electrical Characteristics,  $T_j = 25^\circ\text{C}$  Unless Otherwise Specified**

Characteristics	Symbol	Test Conditions	Min.	Typ.	Max.	Units
Repetitive Peak Reverse Leakage Current	$I_{RRM}$	$T_j = 125^\circ\text{C}, V_R = V_{RRM}$			150	mA
Repetitive Peak Forward Leakage Current	$I_{DRM}$	$T_j = 125^\circ\text{C}, V_D = V_{DRM}$			150	mA
Peak On-state Voltage	$V_{TM}$	$T_j = 125^\circ\text{C}, I_T = 2000\text{A Peak}$ Duty Cycle < 0.1%			1.35	Volts
Threshold Voltage, Low-level	$V_{(TO)1}$	$T_j = 125^\circ\text{C}, I = 15\%, I_{T(av)}$ to $\pi I_{T(av)}$			0.86799	Volts
Slope Resistance, Low-level	$r_{T1}$				0.1703	m $\Omega$
Threshold Voltage, High-level	$V_{(TO)2}$	$T_j = 125^\circ\text{C}, I = \pi I_{T(av)}$ to $I_{TSM}$			1.0951	Volts
Slope Resistance, High-level	$r_{T2}$				0.1226	m $\Omega$
$V_{TM}$ Coefficients, Low-level		$T_j = 125^\circ\text{C}, I = 15\% I_{T(av)}$ to $\pi I_{T(av)}$				$A_1 = 0.60452$ $B_1 = 0.003408$ $C_1 = 3.235E-05$ $D_1 = 0.01293$
$V_{TM}$ Coefficients, High-level		$T_j = 125^\circ\text{C}, I = \pi I_{T(av)}$ to $I_{TSM}$				$A_2 = 2.2748$ $B_2 = -0.17012$ $C_2 = 1.155E-04$ $D_2 = 0.004534$
Typical Delay Time	$t_d$	$T_j = 125^\circ\text{C}, V_D = 1800\text{V}$		3		$\mu\text{sec}$
Typical Turn-off Time	$t_q$	$T_j = 125^\circ\text{C}, I_T = 2000\text{A},$ $t_p > 2\text{msec}, di_R/dt = 5\text{A}/\mu\text{sec}$ $V$ Reapplied = 1500V, $dv/dt = 1000\text{V}/\mu\text{sec}, V_R = 100\text{V}$		250		$\mu\text{sec}$
Minimum Critical $dv/dt$ - Exponential to $V_{DRM}$	$dv/dt$	$T_j = 125^\circ\text{C}, V_D = 0.8 V_{DRM}$	500			V/ $\mu\text{sec}$
Gate Trigger Current	$I_{GT}$	$T_j = 25^\circ\text{C}, V_D = 12\text{V}_{DC}$			250	mA
Gate Trigger Voltage	$V_{GT}$	$T_j = 25^\circ\text{C}, V_D = 12\text{V}_{DC}$			4.5	Volts
Non-Trigging Gate Voltage	$V_{GDM}$	$T_j = 125^\circ\text{C}, V_D = 1300\text{V}$			0.5	Volts
Peak Forward Gate Current	$I_{GTM}$				20	A
Peak Reverse Gate Voltage	$V_{GRM}$				20	Volts

**Thermal Characteristics**

Maximum Thermal Resistance, Double Sided Cooling

Junction-to-Case	$R_{\theta(j-c)}$			0.012	$^\circ\text{C}/\text{W}$
Case-to-Sink	$R_{\theta(c-s)}$			0.002	$^\circ\text{C}/\text{W}$

Powerex, Inc., 200 Hillis Street, Youngwood, Pennsylvania 15697-1800 (412) 925-7272  
 Powerex, Europe, S.A. 428 Avenue G. Durand, BP107, 72003 Le Mans, France (43) 41.14.14

**C782**  
**Phase Control SCR**  
 2300 Amperes Average, 2500 Volts

**Maximum On-State Forward Voltage Drop**  
 ( $T_J = 125^\circ\text{C}$ )

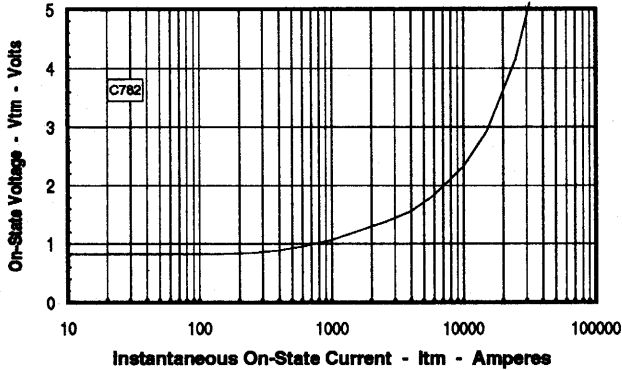

**Maximum Transient Thermal Impedance**  
 (Junction to Case)

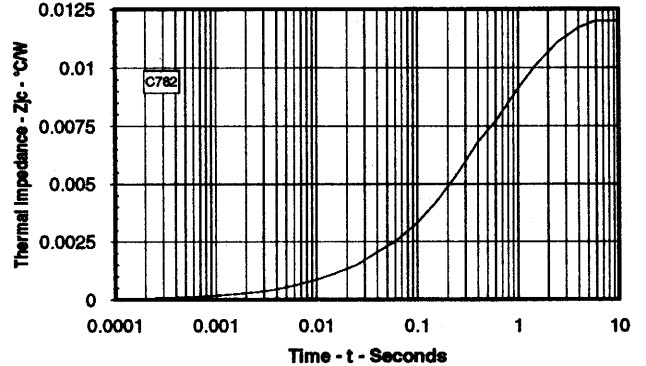

**Maximum On-State Power Dissipation**  
 (Sinusoidal Waveform)

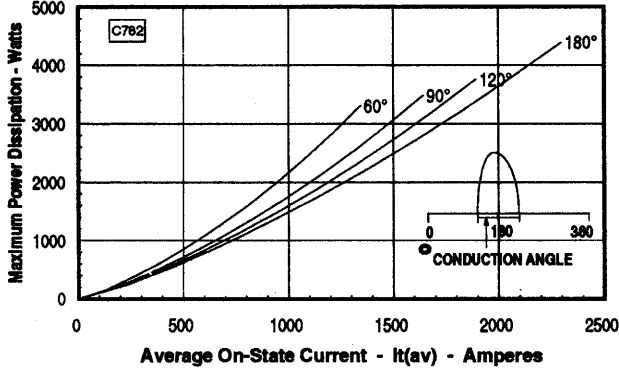

**Maximum Allowable Case Temperature**  
 (Sinusoidal Waveform)

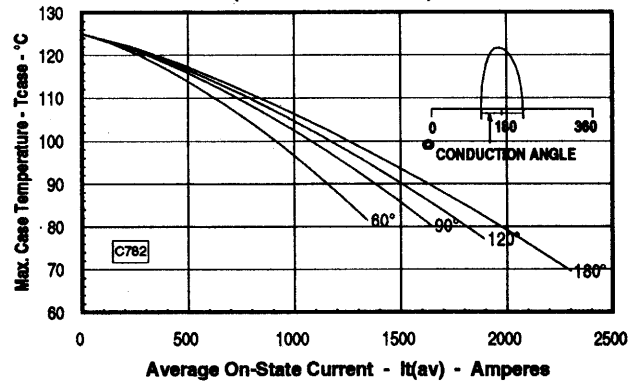

**Maximum On-State Power Dissipation**  
 (Rectangular Waveform)

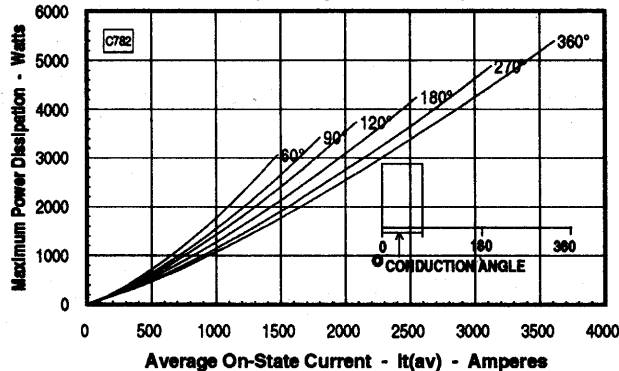

**Maximum Allowable Case Temperature**  
 (Rectangular Waveform)

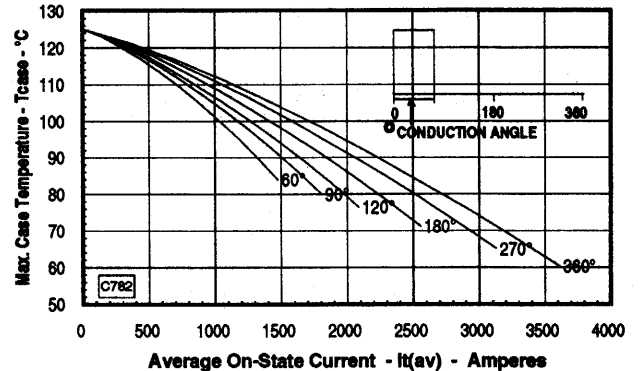

Note: Spreading losses included. Curves are for an inductive load.